

## DEVELOPMENT OF $R - \mu$ RELATION FOR THE SEISMICALLY BASE ISOLATED STRUCTURES USING MODIFIED ABC ALGORITHM

S.A.R. Mirbod, M. Daei<sup>\*,†</sup> and H. Tajmir Riahi  
*Department of Civil Engineering, Faculty of Engineering, University of Isfahan*

### ABSTRACT

In this paper, the effective parameters on the ductility demand of the seismically base isolated structure are investigated, and then a relation between the strength reduction factor and the target ductility is presented. The investigation has been conducted by modelling the base isolated structure as a two degree of freedom model in the OpenSees software, and the possibility of yielding in the superstructure has been considered in the model. Results show that the period of isolator and superstructure have the most effect on the ductility demand, therefore these two parameters beside the strength reduction factor and the target ductility have been used as variables of  $R - \mu$  relation. A nonlinear regression model has been developed for forecasting the relation and the constant parameters of the proposed scheme has been obtained based on an optimization model solved by modified artificial bee colony (ABC) algorithm. A database including 224 models under 20 earthquake records with 2% probability of exceedance in 50 years have been generated for this purpose. Since there is not any explicit closed form formula to calculate the strength reduction factor for a specific target ductility; another optimization model has been developed to calculate the data used as input of the nonlinear regression model. The proposed relation includes two nonlinear functions and it is able to quantify the inelastic performance of base isolated structures for a wide range of earthquake records accurately.

**Keywords:** seismic isolation; strength reduction factor; target ductility; regression model; artificial bee colony algorithm.

Received: 14 March 2016; Accepted: 25 June 2016

---

\*Corresponding author: Department of Civil Engineering, Faculty of Engineering, University of Isfahan

†E-mail address: m.daei@eng.ui.ac.ir (M. Daei)

## 1. INTRODUCTION

Passive vibration control methods provide an alternative to conventional design methods, which are based on ductile response. For instance, in the passive control methods the ground seismic waves can be dissipated by properly engineered dampers instead of non-elastic displacement in the structure. In other words, vibration control methods can help to reduce the seismic response of main structure and therefore less damages are expected to occur in the main structural members.

Many passive control devices such as tuned mass dampers, fluid viscous dampers, viscoelastic dampers, friction dampers, seismic base isolation (BI) systems, metallic yield dampers and tuned liquid mass dampers have been proposed, tested and implemented to mitigate structural vibration effects due to earthquake as well as wind. Meanwhile; seismic base isolation system, which is divided in to two main categories include elastomeric type and friction type, is one of the most practical and economical methods for preventing structural damages under horizontal component of earthquakes. The interest in the application of BI in the seismic control of structures is pervasive throughout the civil engineering over the last three decades. In fact, the optimum design of various types of BI systems in seismic vibration mitigation are well known [1-2]. The basic goal of seismic isolation is to move the fundamental period of a structure away from the predominant period of the earthquake ground motion through the introduction of flexible supports, usually at the foundation level of the structure.

The current design code criteria for seismically based isolated structures lead to elastic behavior of superstructure, therefore most of researches on BI are conducted based on nonlinear response of superstructure. Although this assumption can be reasonable, Ordonez et al. [3], Kikuchi et al. [4] and Thiravechyan et al. [5] showed that more precisely study on BI system based on nonlinear behavior of superstructure is necessary, since the deformations in the superstructure with base isolator can be much more than expected deformation for elastic response.

Inelastic response of a structure will be dictated, in part, by the real structure strength and ductility capacity. Real structure strength, which includes the effects of overstrength, varies considerably as a function of number of stories, structural system, and tributary area, as well as other factors. So with relations between the strength reduction factor and the displacement ductility, the seismic response of the structure can be predicted more precisely, while the effects of these different parameters in the response of the structure can be investigated. These relations have been extensively studied for fixed-base structures by numerous researchers in the past. In general, the proposed relations can be classified into three categories in terms of equation formats. For the first time Newmark et al. [6], and then Lai et al. [7] and Riddel et al. [8] suggested relations in the form of multiline equations. After that Riddel et al. [9] and Vidic et al. [10] forecasted the relation in the format of bilinear equations, and finally Elgadamsi and Mohraz, Arias and Hidalgo, Nassar and Krawinkler, Miranda and Miranda and Bertero proposed nonlinear equations [11-15]. But so far, only Anastasios Tsiavos [16] investigated in similar relations for base-isolated structures. The relation proposed by Anastasios Tsiavos is a bilinear equation for friction isolator with linear superstructure.

In this paper, the relations between strength reduction factor  $R$ , target ductility of structure  $\mu$ , period of structure  $T_s$  and period of base isolation  $T_b$  is proposed, while possibility of yielding in the superstructure and its nonlinear behavior is considered in the model.

The investigation has been conducted using a two-degree-of-freedom model of a base-isolated structure, and a nonlinear regression model has been developed for forecasting the relation. Nonlinear regression modelling is an important tool for determination of a suitable relation and best fitted parameters. This method is widely used in civil engineering [17-19].

In this paper, the constant parameters of nonlinear regression model has been obtained based on optimization model solved by artificial bee colony (ABC) algorithm. For the structural modeling, the open system for earthquake engineering simulation software (OpenSees) has been used, and optimization problem has been coded in the MATLAB software environment.

A database include 224 points has been generated as input for nonlinear regression model optimization. This data has been obtained via nonlinear time history analysis of two degree of freedom model in OpenSees software. Indeed, seismic response of different models under ground motion records have been investigated based on nonlinear time history analysis. Since there is not any certain relation between target ductility and strength reduction factor, another optimization model is proposed for generation of required data. Therefore, accurate strength reduction factor for a specific ductility can be achieved based on this optimization model to use later as input in regression model optimization.

In general, the studies in this paper can be divided into three parts: At first, the effective parameters on the demand ductility of base isolated structures are investigated, then an optimization model is developed to determine the reduction factor of superstructure for different specific target ductility, and finally a relation for  $R - \mu$  is proposed based on nonlinear regression model. For finding the constant parameters of regression model, another optimization model has been proposed, solved by ABC algorithm.

## 2. MODIFIED ARTIFICIAL BEE COLONY ALGORITHM

Artificial bee colony algorithm (ABC) was first proposed by Dervis Karaboga [20]. This algorithm provides an iterative process to search for the optimal solution based on the principles of the natural behavior of a group of bees working together to find food. In this algorithm, bees are divided into three groups of employed bees, onlooker bees, and scout bees. In mathematical models, each solution includes a number of independent variables which have been already specified due to the nature of the problem. Every food source in the algorithm is a possible solution to the problem in the mathematical model.

In first iteration of ABC algorithm, the main food sources are generated randomly. After it the new candidate food position from the old one is generated using Equation (1):

$$v_{ij} = x_{ij} + \varphi_{ij} (x_{ij} - x_{kj}) \quad (1)$$

where  $v$  represents the new candidate for food source  $i$ , index  $k \in \{1, 2, \dots, SN\}$  is randomly chosen from the numbers of food sources, and  $j \in \{1, 2, \dots, D\}$  represents the number of the considered variable to impose changes.  $j$  is selected randomly too.  $SN$  is the number of food sources,  $D$  is the number of independent variables, and  $\varphi_{ij}$  is a random number within  $[-1, 1]$ . In this equation,  $x_{ij}$  represents the  $j$ th variable from the  $i$ th food source.

Both employed and onlooker bees try to improve the solution by selecting a food source and making changes in the selected solution according to Equation (1). The main difference in the working process of employed and onlooker bees is in the selection of food sources. Employed bees examine all the food sources, but onlooker bees are going for food sources with more chance (probability). The probability of each food source is calculated by Equation (2).

$$p_i = \frac{fit_i}{\sum_{n=1}^{SN} fit_n} \quad (2)$$

where  $p_i$  represents the numerical value of the probability of the  $i$ th food source,  $fit_i$  represents fitness for the  $i$ th food source, and  $SN$  is the number of food sources.

If the examination of a food source by a specific number (*limit*) leads to finding no better solution, this food source shall be removed and a new food source shall be randomly generated and substituted. This action is performed by scout bees.

The above-mentioned steps are performed by the number of determined iterations and the solution with the best objective function value is introduced as the solution of the problem.

In order to achieve an optimum solution of a problem, two essential features of exploitation and exploration must be considered. Exploitation is the ability to develop the available answers in order to get better results and is to be sure of spending time for refining an answer, classic approaches in this field perform well. In this situation, there is a possibility of being trapped in local optima (convergence before maturity). The second feature, exploration, means ability of making new and, of course, different answers. Random exploration is needed to be done well in all possible space.

Any of previous cases is not valuable lonely, a method which makes an equivalent of those two cases would be suitable. A procedure is suitable which considers all answers approximately and not exact then converges gradually to the zone with better answer because we cannot have both cases simultaneously.

In ABC algorithm, exploration is performed by scout bees, which is important in the global searching of the search space. Employed and onlooker bees also properly implement exploitation by the local search of space. The important tunable parameters of ABC algorithm are as follows:

$BN$  is the number of bees,  $M CN$  is the number of iterations,  $Ndim$  is the number of independent variables that change at each time of generating a new solution compared with the initial solution, and  $Limit$  is the maximum allowable number of non-improvement of a source [21-22].

To improve the convergence speed of the ABC algorithm, two new features are added to original version of the ABC algorithm as follow:

1- Neighborhood radius factor: This factor is added to Equation (1). In Equation (3), the effect of neighborhood radius factor is shown.

$$v_{ij} = x_{ij} + R_{C_i} \times \varphi_{ij} (x_{ij} - x_{kj}) \quad (3)$$

$R_{C_i}$  is the neighborhood radius factor for  $i$  th iteration. This factor is decreased with the iterations as shown in Equation (4).

$$R_{C_i} = F_r \times R_{C_{i-1}} \quad (4)$$

where  $0 < F_r \leq 1$  is the radius reduction factor. Based on these equations, bees search domain is limited with iterations, therefore the new food position is generated due to the limited changes on the previous food position. This factor is applied, since it is expected that the bees are close enough to the optimal solution after certain number of iteration and then it is necessary to apply small changes to improve the solution gradually.

2- Shock operator: This operator would result to modify some of food sources, if the bees cannot improve the best so far solution anymore after some certain iterations. In fact, this operator defines to raise the algorithm ability to escape from local optimum trap. After  $n$  iterations, this proposed operator comes into play such that if the bees cannot improve the best so far solution after  $m$  consecutive iterations, then half of the worst food source are removed and replaced randomly.

### 3. DESCRIPTION OF THE ANALYTICAL MODEL

As shown in Fig. 1, a model with two degrees of freedom (2DOF) is used in order to simulate the response of seismically base isolated structure.

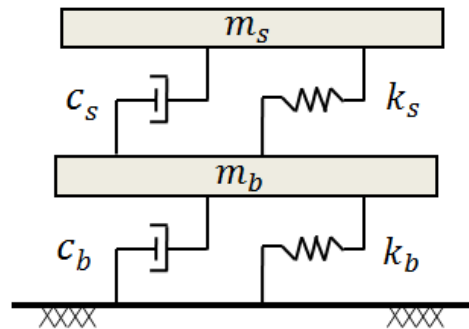

Figure 1. 2DOF model of a seismically base isolated structure

In this model, the base isolation system behavior is considered as linear viscoelastic, and the superstructure is modelled with elastoplastic behavior. As it is shown in Fig. 2.

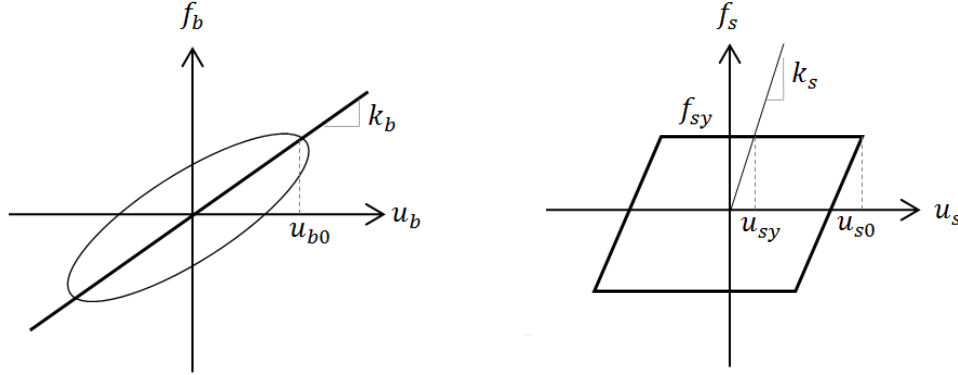

Figure 2. Model of force–displacement relations for a) the isolation system and b) the superstructure

By selecting the damping ratio ( $\xi_s$  and  $\xi_b$ ) and also the fundamental period ( $T_s$  and  $T_b$ ) for the superstructure and the base isolation system, the mass and the stiffness of superstructure and isolation system can be obtained using Equations (5).

$$T_b = 2\pi \sqrt{\frac{m_b + m_s}{k_b}} T_s = 2\pi \sqrt{\frac{m_s}{k_s}} \xi_b = \frac{C_b T_b}{4\pi(m_b + m_s)} \xi_s = \frac{C_s T_s}{4\pi m_s} \quad (5)$$

where  $C_s$  and  $C_b$  is damping coefficient of super structure and base isolation system respectively.

#### 4. GROUND MOTION SET

To both facilitate the development of statistical descriptions of engineering demand parameters and to consider a variety of seismic characteristics, an ensemble of ground motions was selected to represent possible realizations of ground motion at a site. Usually, number of real ground motions which have been recorded in the site, is not enough for doing accurate calculations, therefore the SAC ground motions collection which has been developed by Somerville et al. [23] is used in this paper. In this collection as part of the SAC steel project several ensembles of ground motions include both real and artificial accelerograms, have been developed for the Los Angeles basin. Since the objective of these studies is to identify demand parameter sensitivities to inputs having multiple frequencies of occurrence, two ground-motions ensembles have been selected. Each of the two ensembles contains 10 pairs of acceleration records, and have been developed for return periods of 475 years, and 2475 years. The ground motion records have been scaled so that those are matched to NEHRP1997 [24]

spectra for stiff soil. Fig. 3a and 3b show the spectra for mentioned records and their median (bold line). In this paper, all seismic analyses have been performed under median of these 10 pairs of acceleration records with return periods of 2475 years, to obtain  $R - \mu$  relation, and then the median of these 10 pairs of acceleration records with return periods of 475 years has been used for the control of the proposed relation.

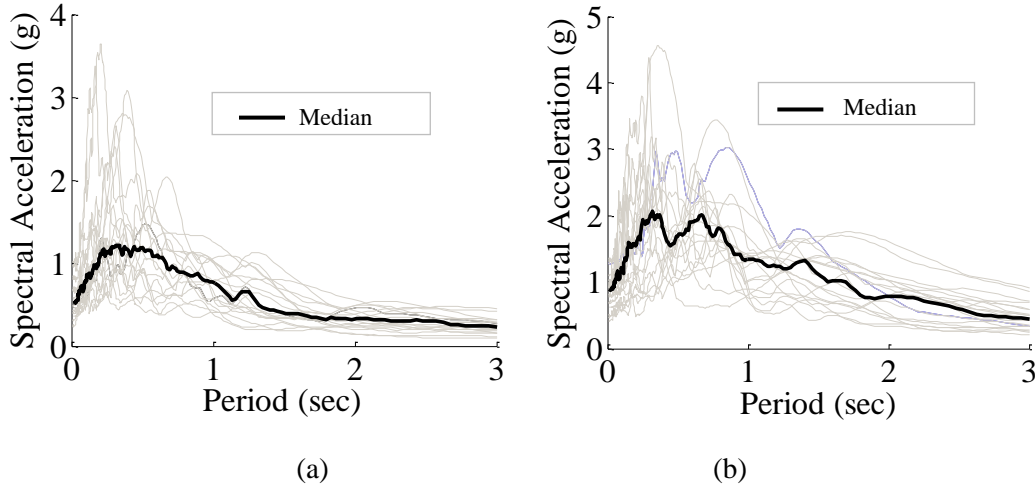

Figure 3. Linear response spectra a) return periods of 475 years, b) return periods of 2475 years

## 5. PARAMETRIC STUDY FOR EVALUATION OF THE DUCTILITY DEMAND

Based on Equation (6), strength reduction factor of a structure is defined as ratio of the maximum force in the linear situation to the yield strength.

$$R = \frac{f_{s0,el}}{f_{sy}} \quad (6)$$

In this equation,  $R$  is the strength reduction factor due to ductility,  $f_{s0,el}$  is the maximum force in the linear situation and  $f_{sy}$  is the yield strength of structure.

In order to make earthquake losses quantitative, damage indices are defined corresponding to damages occurred in the structure as possible. In general, structural damages due to earthquake occurs because of the large permanent deformations in the structure. Therefore, the ductility  $\mu$  which is defined as the ratio of the maximum deformation of the structure in the non-linear situation to the displacement of the yield point, is selected as one of the conventional forms of the damage indices. The ductility can be calculated based on Equation (7).

$$\mu = \frac{u_{s0}}{u_{sy}} \quad (7)$$

where  $\mu$  is ductility,  $u_{s0}$  is the maximum displacement in the non-linear situation of structure and  $u_{sy}$  is the displacement of the yield point.

Based on Equation (8), which determines the relation between ductility and strength reduction factor, if the superstructure behavior is perfect plastic ( $R = 1$ ), then ductility  $\mu$  will equal to 1, and if the strength reduction factor is greater than one ( $R > 1$ ), the ductility  $\mu$  will be greater than 1 too.

$$\mu = \frac{R \cdot u_{s0}}{u_{s0,el}} \quad (8)$$

where  $u_{s0,el}$  is the maximum displacement of the structure in the elastic situation.

In order to achieve a better understanding about ductility demand of seismically base isolated structure, the sensitivity analyses have been performed such that a parameter is selected and to changed, while the other parameters are fixed, and the effects of these changes on the system are investigated.

The initial properties of the superstructure have been assumed as 0.02 for damping ratio and 0.5 seconds for period, and 0.1 and 2 seconds have been selected as the damping ratio and period of the isolation system respectively.

To investigate the effect of nonlinear behavior of superstructure, strength reduction factor has been changed from 1 to 4 as shown. In Fig. 4, the strength reduction factor versus the demand ductility of superstructure has been shown. In the figure, bold line shows median response. According to Fig. 4, and as it is expected, the ductility demand of superstructure increases by increasing in the strength reduction factor. This means that by considering linear behavior for the superstructure, the most portion of earthquake energy will be absorbed by the isolator and therefore the earthquake can have less effect on the structure. But the efficiency of the isolator decreases by making super structure weaker, because the ductility demand has increased 10 times only with decreasing super structure strength by 0.66.

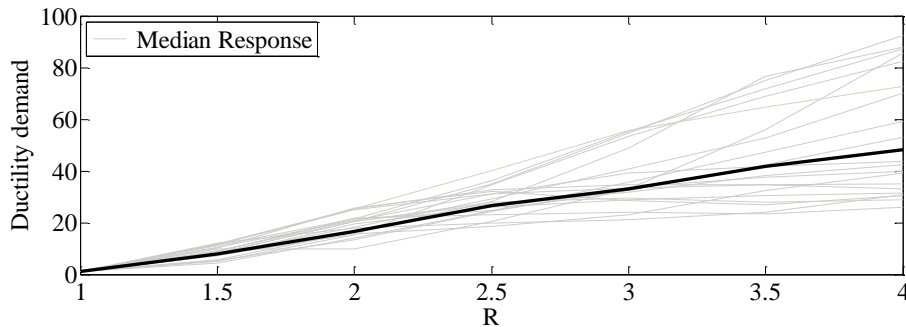

Figure 4. The effect of strength reduction factor of superstructure on the ductility demand



In the Fig. 5, the effect of changing in the strength of superstructure based on 4 different kinds of isolator with periods of 1, 2, 3, and 4 seconds have been investigated. According to Fig. 5, the ductility demand increases in all cases by increasing of the strength reduction factor. But for a more flexible isolator (period increasing), ductility demand increases more. Therefore, in the case of the superstructure with strength reduction factor of 1.5, the structure based on an isolator with 4 seconds period compared to which with 1 second period has ductility demand 5 times greater.

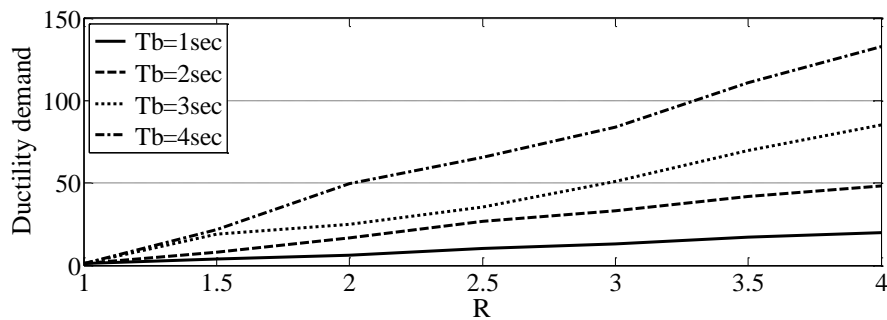

Figure 5. The effect of base isolation system stiffness on the ductility demand

To investigate the effect of base isolation system damping ratio on the ductility demand, values of 0.02, 0.06 and 0.1 have been selected. In Fig. 6, the effect of increasing in damping ratio of base isolation system is shown for weak up to stiff superstructure. As it is shown, although changing in the damping ratio of base isolation system does not have much effect on the ductility demand of the superstructure, especially when the strength reduction factor is less than 2, use of the isolator with higher damping ratio in the weak structures can cause an increase in the ductility demand of superstructure.

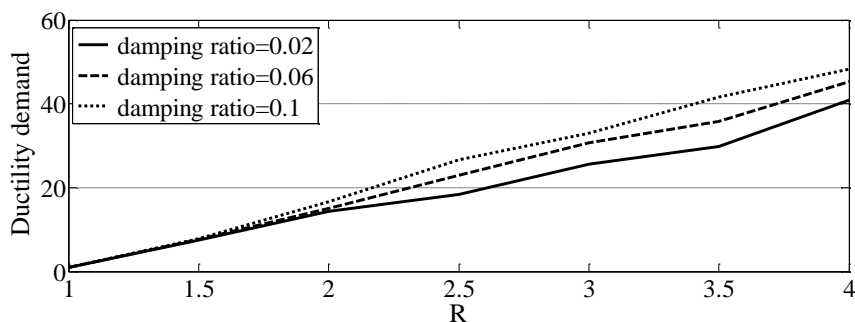

Figure 6. The effect of base isolation system damping ratio on the ductility demand of superstructure

As another important parameter is the fundamental period of structure, therefore the effect of superstructure stiffness (via changing the fundamental period of superstructure) on the ductility demand has been investigated in the Fig. 7. For this purpose, 0.5, 1.0, and 1.5

seconds have been chosen for the period of superstructure. The changes of the ductility demand versus the strength reduction factor in these three situation have been shown by Fig. 7. As it is shown, the ductility demand increases for the stiffer superstructure (decreasing in the fundamental period).

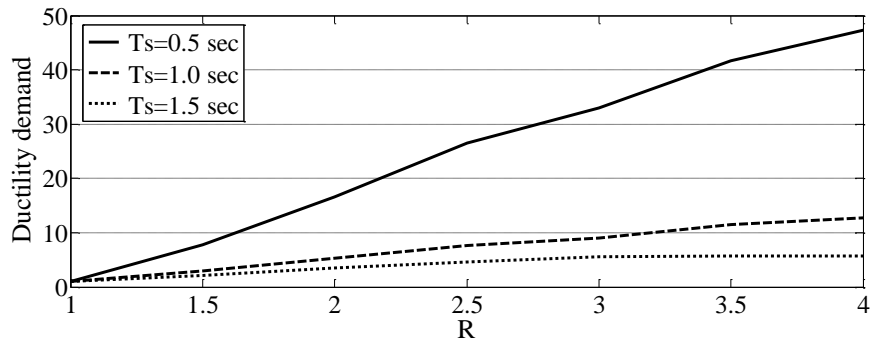

Figure 7. The effect of superstructure stiffness on the ductility demand

According to Fig. 7, it can be concluded that the ratio of isolator stiffness to superstructure stiffness has significant effect on the ductility demand of superstructure. Therefore, the effect of ratio of the isolator stiffness to the superstructure stiffness on the ductility demand has been investigated by Fig. 8. The ratio of the isolator stiffness to the superstructure stiffness has been considered from 0.1 to 1. According to Fig. 8, there are two spectrum regions for the base isolated structure. In the first region, which relates to the stiffer superstructure, ductility demand increases significantly by decreasing in the strength reduction factor of the superstructure. This region can be regarded as acceleration sensitive region. In the second region, the ductility demand decreases by increasing the stiffness of the superstructure and tends to the strength reduction factor approximately. Transformation from the first region to the second region occurs for the superstructure which its period is half of the isolator period. Therefore, the distinctive criterion  $T_c$  of these two spectrum regions equals to  $2T_s = T_b$ .

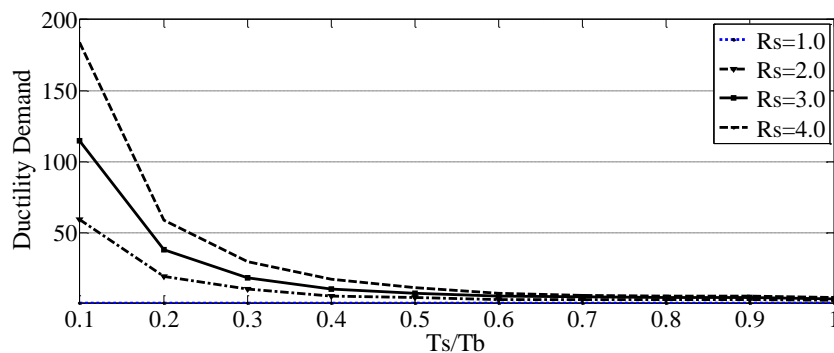

Figure 8. The effect of ratio of the isolator stiffness to the superstructure stiffness on the ductility demand

Since the effect of the isolation system damping on the ductility demand is little, only the periods of base isolation system and superstructure have been considered as variables to calculate the strength reduction factor for a specific target ductility.

## 6. AN OPTIMIZATION MODEL TO CALCULATE THE STRENGTH REDUCTION FACTOR

Since there is not any explicit closed form formula to calculate the strength reduction factor for a specific target ductility, and also the relation between the strength reduction factor and the target ductility is not always direct, so it is necessary to apply a lot of trial and error iterations to obtain the exact strength reduction factor related to a specific target ductility.

Therefore, in this paper an optimization model has been developed instead of applying trial and error method to obtain more accurate strength reduction factor for a specific target ductility rapidly.

In the proposed optimization model, the strength reduction factor is the decision variable, which is a continuous variable between 1 and 10, and the objective function is defined by Equation (9).

$$O.F = \min \left( \sum \left| \frac{R \cdot u_{so}}{u_{so,el}} - \mu_{target} \right| \right) \quad (9)$$

To calculate Equation (9), it is required that two models are generated by OpenSees software and the time history analysis is performed for these model. The first model is simulated for the elastic behavior of superstructure, and the last model for nonlinear superstructure.

In the first model, the time history analysis under each record of earthquakes is performed in order to calculate the maximum elastic force and the maximum displacement  $u_{so,el}$  of superstructure. Then the obtained maximum elastic force is used as strength of superstructure in the second model in order to calculate the maximum displacement of nonlinear superstructure  $u_{s0}$ .

This process has been repeated for 4 target ductilities  $\mu_{target}$  includes 1, 2, 3, and 4. And the following models (for each value of target ductility) have been studied:

For the fundamental period of the base isolation system values of 1, 1.5, 2, 2.5, 3, 3.5, and 4 seconds have been considered. For the fundamental period of the superstructure values of 0.1, 0.5, 1, 1.5, 2, 3, 4, and 5 seconds have been considered. The mass ratio of isolator to superstructure has been assumed 0.1, and the damping ratio for isolator and superstructure have been considered 0.1 and 0.02 respectively.

As result, 224 optimization problems have been generated and solved to find 224 points, which are inputs for nonlinear regression model. The modified ABC algorithm has been applied to obtain optimal solution. Based on parameters tuning of ABC algorithm, number of food source has been considered 20, maximum iteration number 80, *limit* 6, and *ndim* 1.

To clarify the total procedure of the proposed optimization method, it is shown by flow chart in the Fig. 9.

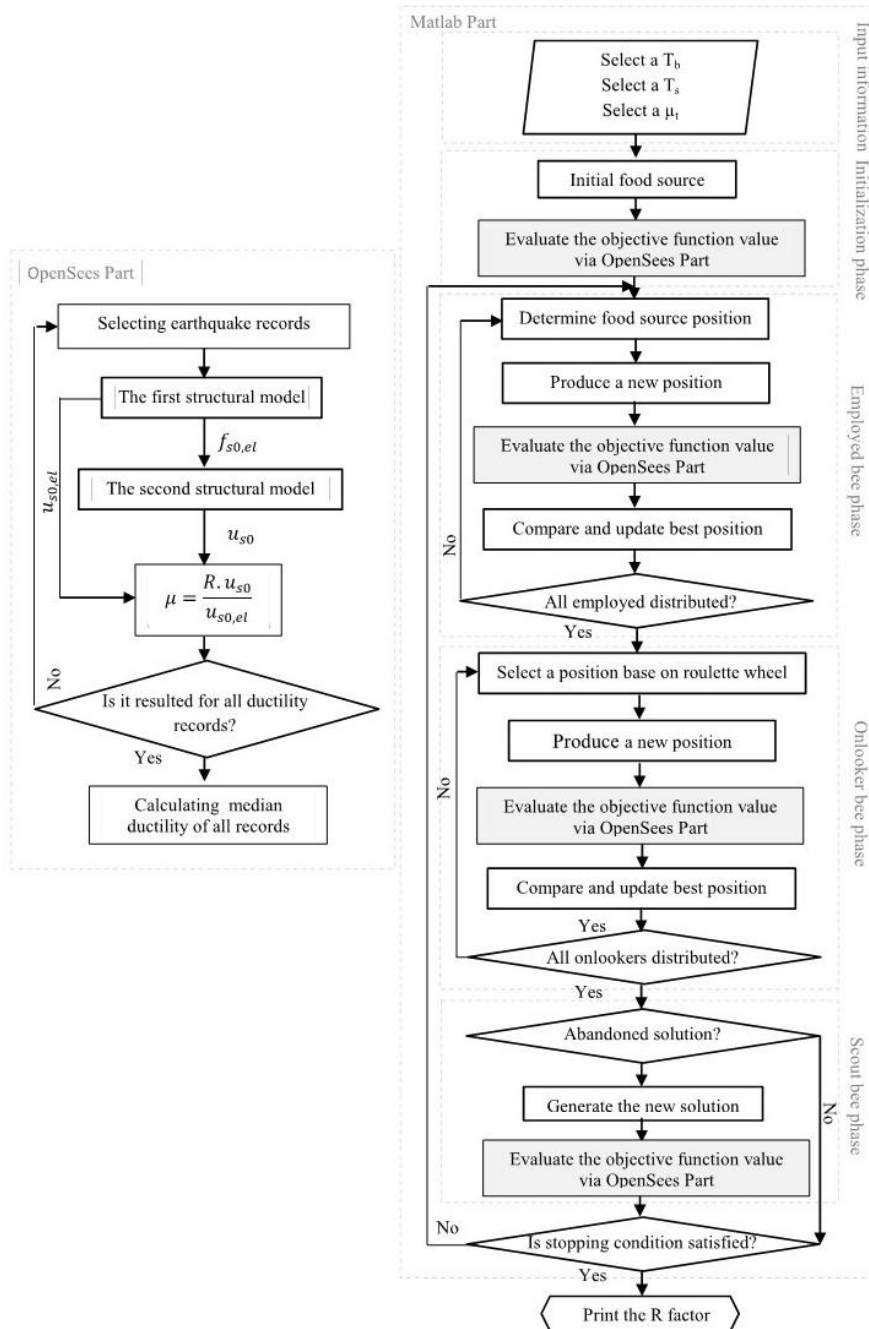

Figure 9. Flowchart of the proposed optimization model for strength reduction factor calculation

## 7. GENERAL SCHEME OF THE PROPOSED NONLINEAR REGRESSION MODEL

Determination of a suitable model and best fitted parameters has a widespread application in various aspects of engineering. In statistical modelling, regression analysis is a statistical process for estimating the relationships among variables. Regression analysis is used to understand which among the independent variables are related to the dependent variable, and to explore the forms of these relationships. Nonlinear regression is a form of regression analysis in which observational data are modelled by a function which is a nonlinear combination of the model parameters and depends on one or more independent variables.

In this paper, the regression analysis has been used to estimate the relation between  $R - \mu$ . For adapting regression model parameters, a heuristic method has been proposed via solving an optimization model by ABC algorithm.

Based on the results of previous section, initial scheme of  $R - \mu$  relation shall be satisfied the following equations:

$$\{R_S \rightarrow 1.0 | \forall \mu, T_s \rightarrow 0\} \quad (10)$$

$$\{R_S = 1.0 | \mu = 1.0, \forall T_s\} \quad (11)$$

According to Equation (10), for any target ductility value the strength reduction factor tends to 1 when the superstructure becomes stiff ( $T_s \rightarrow 0$ ). On the other hand, based on Equation (11) when the superstructure behaves linearly ( $\mu = 1.0$ ), the related strength reduction factor will equal 1.

Furthermore, to obtain a proper scheme of  $R - \mu$  relation, effect of different parameters on the value of strength reduction factor have been investigated, while one parameter is changed and others are constant. Some of the obtained results are shown in the Fig. 10.

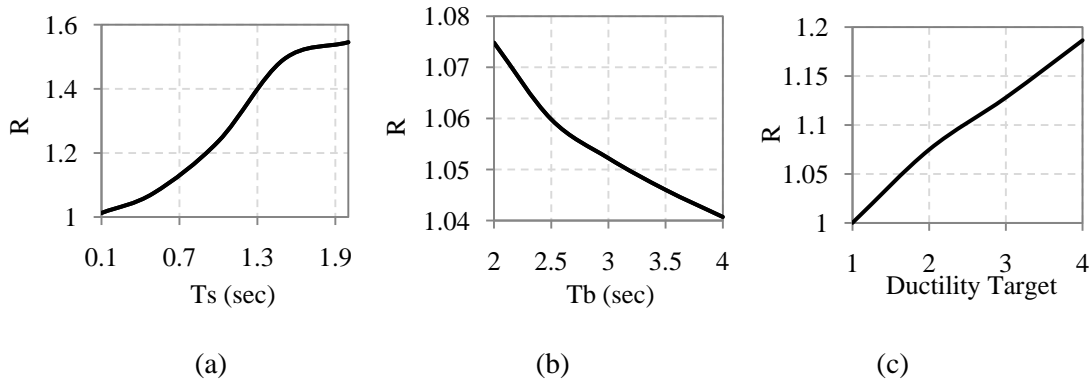

Figure 10. Effect of different parameters on the strength reduction factor  
 (a) Superstructure period:  $\mu = 2$  and  $T_b = 2$  sec, (b) Isolator period:  $\mu = 2$  and  $T_s = 0.5$  sec, (c)  
 Target ductility with  $T_b = 2$  sec and  $T_s = 0.5$  sec

As shown in the Fig. 10, the strength reduction factor has direct relation with target ductility and superstructure period, while it is inversely related to isolator period.

According to all of these properties, general scheme of  $R - \mu$  relation has been considered as Equation (12).

$$f(x) = \frac{f_1(x) \cdot f_2(x)}{f_3(x)} + 1 \quad (12)$$

where  $f_1(x)$ ,  $f_2(x)$ , and  $f_3(x)$  are functions related to target ductility, superstructure period and isolator period; respectively. These functions based on their corresponding variables has been considered as Equation (13).

$$\begin{aligned} f_1(x) &= (\mu - 1)^{x_1} \\ f_2(x) &= (x_2 T_s + x_3)^{x_4} \\ f_3(x) &= (x_5 T_b + x_6)^{x_7} \end{aligned} \quad (13)$$

In Equation (13), unknown parameters of  $x_1$  to  $x_7$  are constant parameters of the nonlinear regression model, which are considered as decision variables for the proposed optimization model. Indeed, the parameter of  $x_1$  to  $x_7$  are obtained via solving the proposed optimization model by modified ABC algorithm. The considered upper bound and lower bound for each  $x_i$  are mentioned in Table (1).

Table 1: The upper bound and lower bound of decision variables

	$x_1$	$x_2$	$x_3$	$x_4$	$x_5$	$x_6$	$x_7$
Lower Bound	0	-1	-1	0	-1	-1	0
Upper Bound	2	2	2	2	2	2	2

## 8. AN OPTIMIZATION MODEL FOR FINDING $R - \mu$ RELATION

To define the proper objective function for this problem, there is a need in quantifying the validity of a fit by some measure which discriminates a good from a bad fit. Different fitness functions are proposed for evaluating a nonlinear regression model. In this paper, two kind of fitness function has been considered. For the first objective function, the sum of the absolute values of errors (differences between the actual values and the predicted values by relation) has been used to be minimized as mentioned in Equation (14).

$$O.F. 1 = \min \sum |f(x) - R| \quad (14)$$

Although the total errors in the model is minimized based on Equation (14), and it can be a good criteria from this aspect, but high and low errors are similar weight (effect) in the fitness function. In other words, minimum of sum can be obtained due to large number of small errors or a few number of big errors. Therefore another objective function has been considered too, as Equation (15).

$$O.F.2 = \min_x \{ \max\{|f(x) - R|\} \} \quad (15)$$

In Equation (15), the maximum error (difference between the actual value and the predicted value by relation) is minimized, therefore it is expected that the errors for all the points become approximately uniform. It shall be mentioned that the total error (sum of the errors) may be larger than what is obtained from the previous objective function.

Since  $\frac{T_b}{2}$  was obtained as the spectrum distinctive criterion, the data were divided based on this criterion. Indeed, it is expected that there are two different  $R - \mu$  relations for  $T_s$  larger than  $\frac{T_b}{2}$  and for  $T_s$  smaller than  $\frac{T_b}{2}$ . Therefore, the data have been divided in two groups, and the proposed optimization model has been solved two times by the modified ABC algorithm for each group of data.

Based on parameters tuning of ABC algorithm, number of food source has been considered 60, maximum iteration number 300, *limit* 50, and *ndim* 7. In definition of neighbourhood radius factor operator, the initial neighbourhood radius factor  $R_{c_i}$  and the radius reduction factor  $F_r$  have been considered as 1 and 0.9 respectively.

The shock operator has been considered such that after pass the half of maximum iteration number (150), if the best so far solution cannot be improved by bees after pass 30 consecutive new iterations, then half of the worst food source are removed and replaced randomly.

Fig. 11 shows the convergence histories of objective function in two cases with and without shock operator.

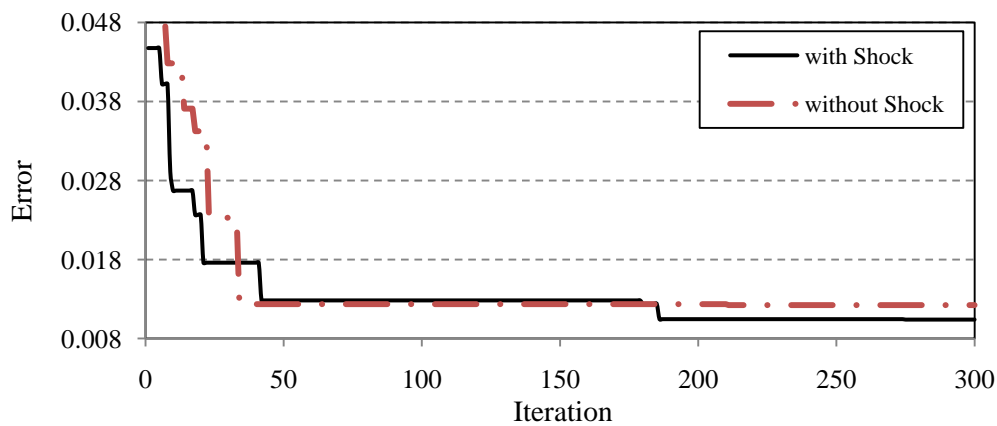

Figure 11. Convergence history of the proposed optimization model

As shown in the Fig. 11, the use of shock operator helps the algorithm to improve the solution in the iteration number of 170.

Finally, the proposed  $R - \mu$  relation was obtained as two nonlinear functions shown in Equation (16). The  $\alpha$  value in this equation are mentioned in the Table (2) based on target ductility.

$$R = \begin{cases} \frac{(1.9T_s)^{1.2}(\mu - 1)}{(1.3T_b + 0.8)^{1.9}} + 1 & , for T_s \leq T_b/2 \\ \frac{(1.1T_s - 0.94)^{0.43}(\mu - 1)^\alpha}{(T_b - 0.15)^{0.7}} + 1 & \end{cases} \quad (16)$$

Table 2:  $\alpha$  value in equation (16) based on target ductility

$\alpha$	Target ductility
0.94	3
0.90	4

It shall be noted that since the codes suggest that the period of base isolation system must be at least twice of the superstructure period to get proper structural performance ( $T_s \leq T_b/2$ ), therefore the first part of proposed Equation (16) would be more practical.

For the first part of Equation (16), the maximum absolute error and the mean of absolute errors are 6% and 2% respectively. And for the second part of Equation (16), the maximum absolute error and the mean of absolute errors are 10% and 6% respectively.

For better evaluation, the proposed relation and the points of actual values are shown in Fig. 12.

In Fig. 12, bold points show the spectrum distinctive criterion, which is limit between the first part and the second part of Equation (16).

## 9. EVALUATION OF THE PROPOSED $R - \mu$ RELATION

As it was discussed before, a database was generated to use as input of regression model. In order to evaluate the efficiency of the proposed  $R - \mu$  relation for the different probability levels of earthquakes, a new data collection was generated related to the acceleration records with return periods of 475 and then for this data the calculated actual values were compared with the corresponding values obtained from the proposed relation.

To generate new data, the target ductility and the isolator period were assumed 2 and 2 seconds respectively, and then the actual strength reduction factors were calculated based on flowchart shown in Fig. 9 for acceleration records with return periods of 475 and 2475 years. The results are shown in Fig. 13.



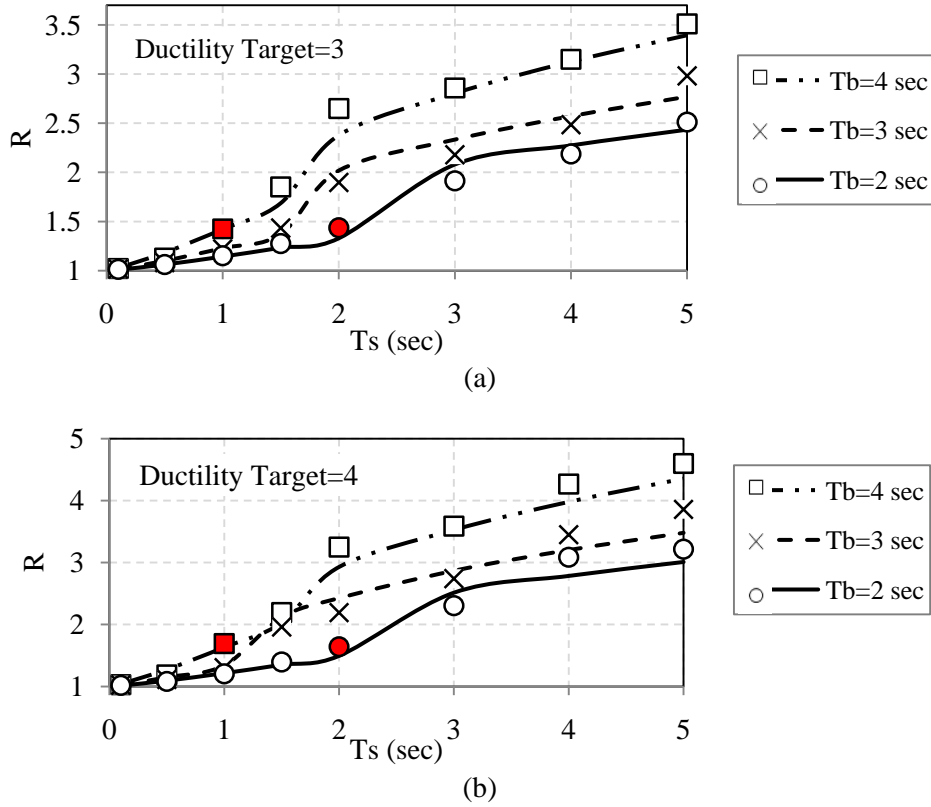

Figure 12. Comparison between the proposed relation and the actual points

As it is shown, the relation can calculate the strength reduction factor with good accuracy, even for the acceleration records with return periods of 475.

From the other aspect, the accuracy of the proposed relation is compared with those proposed by Tsiavos et al. [16].

Tsiavos and et al. [16] have suggested a  $R - \mu$  relation for the isolated structure based on bilinear behaviour of isolator. This relation is as mentioned in:

$$R = \begin{cases} 1 \\ \frac{(\mu - 1)^\alpha T_s}{T_b + 1} + 1 \\ \mu \end{cases} \quad , \text{ for } T_s \leq (\mu - 1)^{1-\alpha} (T_b + 1) \quad (17)$$

The comparison between the proposed relation (Equation (16)) and the Tsiavos relation (Equation (17)) is shown by Fig. 14. This figure has been prepared for the case with target ductility 2 and isolator period 3 seconds. In the Fig. 14-a, the proposed relation has been drawn by the continuous line and the Tsiavos relation by the dash line. The actual values have been shown by separate points. Fig. 14-b shows the error percentage. As it is shown, the maximum absolute error for the proposed relation is 6% and the maximum absolute error

for the Tsiavos relation is 11%. For all the points, the proposed relation has been able to calculate the strength reduction factor more accurate than the Tsiavos relation.

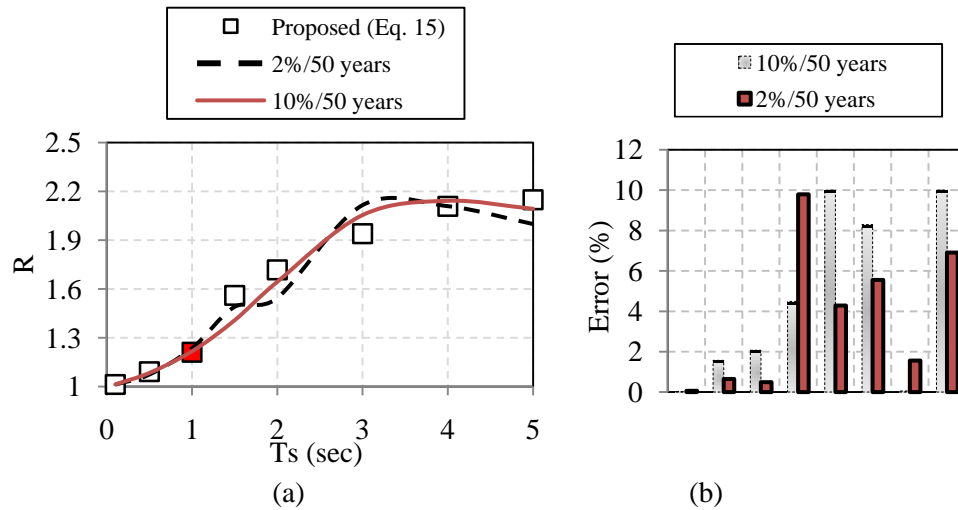

Figure 13. (a) Comparison between results of the proposed relation and the actual values related to acceleration records with return periods of 475 and 2475 years, (b) Comparison based on error percentages

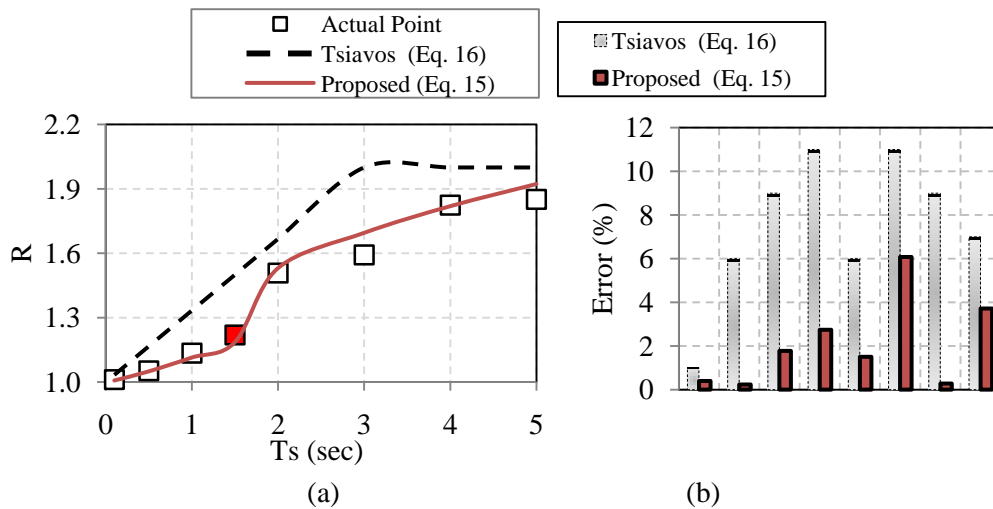

Figure 14. (a) Comparison between results of the proposed relation and the Tsiavos relation, (b) Comparison based on error percentages

### 10. CONCLUSIONS

In this paper, the relations between strength reduction factor  $R$ , target ductility of structure

$\mu$ , period of structure  $T_s$  and period of base isolation  $T_b$  is proposed, while possibility of yielding in the superstructure is considered in the model. The proposed relation includes two nonlinear functions and the distinctive criterion  $T_c$  of these two spectrum regions equals to  $2T_s = T_b$ . Compared to the fixed base structures, the acceleration sensitive region of the response of inelastic base isolated structures extends towards longer periods.

The proposed relation is able to quantify the inelastic performance of base isolated structures for a wide range of earthquake records. The accuracy of the proposed relation is significantly improved compared with the previous relation by Tsiavos.

## REFERENCES

1. Baratta A, Corbi I. Optimal design of base-isolators in multi-storey buildings, *Comput Struct* 2004; **82**(23-26): 2199-209.
2. Mohebbi M, Dadkhah H, Shakeri K. Optimal hybrid base isolation and MR damper, *Int J Optim Civil Eng* 2015; **5**(4): 493-509.
3. Ordonez D, Foti D, Bozzo L. Comparative study of the inelastic response of base isolated buildings, *Earthq Eng Struct Dyn* 2003; **32**: 151-64.
4. Kikuchi M, Black CJ, Aiken ID. On the response of yielding seismically isolated structures, *Earthq Eng Struct Dyn* 2008; **37**: 659-79.
5. Thiravechyan P, Kasai K, Morgan TA. Response of base isolated structures considering inelastic behavior of superstructure, *Proceedings of the 15th World Conference On Earthquake Engineering*, Lisbon, Portugal, 2012.
6. Newmark NM, Hall WJ. Seismic design criteria for nuclear reactor facilities, Report 46, *Building Practices for Disaster Mitigation, National Bureau of Standards* 1973; 209-36.
7. Lai SP, Biggs JM. Inelastic response spectra for aseismic building design, *J Struct Div, ASCE* 1980; **106**: 1295-1310.
8. Riddell R, Newmark NM. Statistical analysis of the response of nonlinear systems subjected to earthquakes, Structural Research Series No. 468, Civil Engineering Studies, University of Illinois, Urbana-Champaign, IL, 1979.
9. Riddell R, Hidalgo PA, Cruz EF. Response modification factors for earthquake resistant design of short period buildings, *Earthq Spectra* 1989; **5**: 571-90.
10. Vidic T, Fajfar P, Fischinger M. Consistent inelastic design spectra: strength and displacement, *Earthq Eng Struct Dyn* 1994; **23**: 502-21.
11. Elghadamsi FE, Mohraz B. Inelastic earthquake spectra, *Earthq Eng Struct Dyn* 1987; **15**: 91-104.
12. Hidalgo PA, Arias, A. New chilean code for earthquake resistant design of buildings, *Earthq Eng* 1990; **2**: 927-36.
13. Nassar AA, Krawinkler H. Seismic demands for SDOF and MDOF systems, Report No. 95, The John A. Blume Earthquake Engineering Center, Stanford University, Stanford, 1991.

14. Miranda E. Evaluation of site dependent inelastic seismic design spectra, *J Struct Eng (ASCE)* 1993; **5**: 1319-38.
15. Miranda E, Bertero VV. Evaluation of strength reduction factors for earthquake resistant design, *Earthq Spectra* 1994; **10**: 357-79.
16. Tsiavos A, Vassiliou MF, Mackie KR, Stojadinovic B. Ry- $\mu$ -Tn relations for seismically isolated structures," *4th ECCOMAS Thematic Conference on Computational Methods in Structural Dynamics and Earthquake Engineering*, Kos Island, Greece, 12–14 June 2013.
17. Kwak H. G, Kwak J. H. An improved design formula for a biaxially loaded slender RC column, *Eng Struct* 2010; **32**(1): 226-37.
18. Fattahi H. Prediction of earthquake induced displacements of slopes using hybrid support vector regression with particle swarm optimization, *Int J Optim Civil Eng* 2015; **5**(3): 267-82.
19. Fattahi H. A hybrid support vector regression with ant colony optimization algorithm in estimation of safety factor for circular failure slope, *Int J Optim Civil Eng* 2016; **6**(1): 63-75.
20. Karaboga D. An idea based on honey bee swarm for numerical optimization, Technical Report, TR06, Erciyes University, 2005.
21. Basturk B, Karaboga D. An artificial bee colony (ABC) algorithm for numeric function optimization, *In: Proceedings of the IEEE Swarm Intelligence Symposium, Indianapolis*, Indiana, USA, 2006.
22. Karaboga D, Basturk B. A powerful and efficient algorithm for numerical function optimization: artificial bee colony (ABC) algorithm, *J Global Optim* 2007; **39**: 459-71.
23. Somerville P, Anderson D, Sun J, Punyamurthula S, Smith N. Generation of ground motion time histories for performance-based seismic engineering, *Proceedings on the 6th National Earthquake Engineering Conference*, Seattle, 1998.
24. NEHRP commentary on the guidelines for the seismic rehabilitation of buildings, Federal emergency management agency, 1997.