

Evaluation of Tool Selection Rules In The Flexible Manufacturing System

V.K.Chawla^{*1}, A.K.Chanda² & Surjit Angra³

Received 8 May 2019; Revised 26 January 2020; Accepted 16 February 2020; Published online 31 March 2020
© Iran University of Science and Technology 2020

ABSTRACT

The selection of an appropriate cutting tool for the production of different jobs in a flexible manufacturing system (FMS) can play a pivotal role in the efficient utilization of the FMS. The selection procedure of a cutting tool for different production operations becomes more significant with the availability of similar types of tools in the FMS. In order to select and allocate appropriate cutting tools for various production operations in the FMS, the tool selection rules are commonly used. The application of tool selection rules is also observed to be beneficial when a system demands two or more tools for the production operations at different work centers at the same time in the FMS. In this paper, investigations are carried out to evaluate the performance of different tool selection rules in the FMS. Moreover, some new tool selection rules are introduced whose significance is reported here. The performance of the tool selection rules is evaluated by simulation with respect to different performance parameters in the FMS, namely makespan, mean work center utilization (%), and mean automatic tool transporter (ATT) utilization (%).

KEYWORDS: Autonomous tool transporter; Flexible manufacturing system; Tool selection; Rules; Simulation.

1. Introduction

The flexible manufacturing systems (FMSs) are popularly used for profitable production operations of a different mix of job types. The FMSs are formed mainly by a combination of various types of production components such as machining centers, assembly centers, material handling components, storage, retrieval components, and inspection centers to name a few [14], [18], [31], [2], [5], [2-5,6].

All the FMS components complete their production assignments with high speed and accuracy under centralized or decentralized automatic computer control. The automatic machining centers are capable to carry out one or more than one machining operation on different

types of jobs, which ensures the production of jobs with minimum setup time. In advanced machining centers, during a machining operation, the job remains within the machining center until all the machining operations are completed, which also reduces the number of job transfers from one machining center to another within the FMS facility [29], [30], [15], [9-13], Sharma et al. (2020)). This is the reason for keeping all types and copies of cutting tools within the tool magazine of machining centers so that the required machining operation can be performed on the job without any delay. Upon the completion of a machining operation on the job, the cutting tool is placed back into the tool magazine, and the cutting tool remains un-operational till a similar machining sequence is called in the FMS. This may cause lower tool and machine center utilization in the FMS and also lowers down the overall makespan in the FMS. In order to scale up tool and machine center utilization, the un-operational cutting tools must be shared by different machining centers installed in the FMS facility so as to minimize cutting tool requirement and also increase the makespan in

*
Corresponding author: V.K.Chawla
vivekchawla@igdtuw.ac.in

1. Department of Mechanical and Automation Engineering, Indira Gandhi Delhi Technical University for Women, Delhi, India.
2. Department of Mechanical and Automation Engineering, G.B. Pant Engineering College, Delhi, India.
3. Department of Mechanical Engineering, National Institute of Technology, Kurukshetra, Haryana, India.

the FMS [16-17].

While performing machining operations on the jobs, the machining centers require different cutting tools in the FMS. Sometimes, a similar cutting tool is required by two or more machining centers for similar or different machining operations. The automatic tool transporters (ATT) are mainly used for transferring cutting tools from one machining center to another in the FMS, as also portrayed in Figure 1. In order to transfer tools from one machining center to another in the FMS, different tool selection rules are applied by the ATT. In this study, the performance of eight types of tool selection rules is evaluated for the FMS, as portrayed in Figure 1. The simulation is used to gauge the performance of different tool selection rules against different performance factors of the FMS, namely makespan, mean work center utilization (%), and mean automatic tool transporter (ATT) utilization (%).

2. Literature Review

The ATTs are extensively used to transport different tools from a tool magazine of a work center to another in the FMS. The role of ATTs becomes more significant in the FMS when FMS is operating under a tool sharing environment. The tool sharing in FMS can significantly optimize the utilization of tools required for the completion of production operations, increase flexibility, and also minimize the investment of funds on tooling component in the FMS, leading to profitable production operations in the FMS. The selection of tools for sharing and transfer can be carried out by using different tool selection rules so as to minimize the makespan in the FMS, increase the throughput of the FMS, and optimize the ATT operations in the FMS [28]. reported results drawn from the experiments related to different operation procedures in the FMS. The FMS is composed of nine work centers and an inspection center interconnected with the automated material handling systems. The authors considered the operation and tooling allocation policies in a real-time job flow control scenario and used simulation to test different alternative approaches. The authors found that the FMS to be significantly dependent on the applied load and control procedures and the weighted shortest process time (SPT) rule performed best and significantly improved the throughput of the FMS in the performed simulation experiment. [4] attempted to analyze the effectiveness of different tools, job variety, and job similarities on the two types of tool

changes. Authors with a high variety of scheduling decisions are constrained. The authors observed the development of a few job launch rules for the minimization of tool changes to be less effective. The dynamic job selection from queues with an objective to minimize the frequency of tool changes was also observed to be less effective. The authors also presented a simulation-based tool change computation model for the FMS. [16] considered a case of an automobile ancillary in which the cylinder head and blocks are to be batch produced on four work centers in the FMS. The authors analyzed the aforesaid production scenario by simulation so as to reduce the fund investments in tools by proposing a tool sharing environment among the work centers and by using the ATTs in the FMS. The production process plan, tool life, tool transportation time, tool handling time, and tool mix are supplied as input to the simulation program. The output yield indicates that, after reducing the fund invested in the tooling, the FMS can still maintain its production rate during the production of jobs. It is also observed that the factor for fund investments in tooling outperforms the extra fund investments in the ATTs for the FMS. [23] observed tool management as one of the significant aspects of FMS operations software. In order to apply proper tool management in the FMS, the FMS hardware/software, part programming, manufacturing control, etc. must be holistically considered. Authors mentioned that in order to yield high throughput in the FMS, the tool management, tool transportation, tooling data management, tooling maintenance, and tooling process control are some of the significant tasks that should be performed by the tool management software in the FMS. [23] developed a generic software application, which is observed to be applicable to various types of FMS and flexible assembly systems. [17] discussed different tool loading and queuing methods for different work centers in the production shop. Authors proposed tool borrowing, tool returning procedure, and heuristic and dispatching rules in a real-time production scenario with an objective to increase the throughput of the production shop. [1] presented and compared four different tool allocation and scheduling methods by using three-part scheduling rules. Authors found that the grouping and assignment of tools to different machines performed better than the other tool assignment procedures, namely tool migration procedure or tool assignment based on tool clustering. [24] worked on job sequencing, job allocation, and tool loading issues in the FMS

after considering the tool borrowing procedure from different machine tools available in the FMS. The authors used three different heuristic procedures so as to minimize the formulated objective function of total tardiness for given jobs. The authors used sequential, scheduling, and iterative procedures as heuristics. From the results, it is observed that the iterative heuristic procedure outperforms other applied heuristics for solving the random issues in the FMS. The authors mentioned that the simultaneous consideration of scheduling and loading issues in the FMS could improve the solution yield significantly. [3] proposed a heuristic based on tool life and tool size ratio for the tool selection and allocation in the FMS. It was observed that the proposed heuristic considers tools had a higher ratio of tool life to tool size after evaluating different production operations at the work centers in the FMS. The authors also discussed various benefits associated with the significant tooling decisions in the FMS with a practical approach. [21,22] applied simulation to determine the effect of different scheduling rules controlling the job launching and tool selections in two different scenarios of the FMS. In the first scenario, the work centers, tool transporter, and job transporter are considered to be 100 % reliable and always available for work in the FMS. However, in the second scenario, those are considered to be exposed to different failures.

The authors used different scheduling rules for the job launching and tool selection work and found the performance of SPT and EMDD rules to be better than other applied scheduling rules. In order to gauge the performance of different scheduling rules, the authors considered different performance measures: mean waiting time, mean flow time, mean tardiness, and the percentage of tardy jobs. [26] discussed a colored Petri-Net procedure so as to implement a robust tool sharing and control method. The proposed colored Petri-Net procedure minimized the number of tools requirements in the FMS and, also, provided an optimum sequence. [25] solved a multi-objective optimization issue by using a novel integrated heuristic approach with an objective to increase the workload of parts and minimize makespan in the FMS and total loading of FMS.

From the literature review, it is clearly evident that a research gap for gauging the effect of different tool selection rules on the performance of FMS exists. In order to bridge the aforementioned research gap in the present study, a simulation approach is used to find the best tool selection rule for different performance parameters of the FMS: makespan, mean work center utilization (%), and mean automatic tool transporter (ATT) utilization (%).

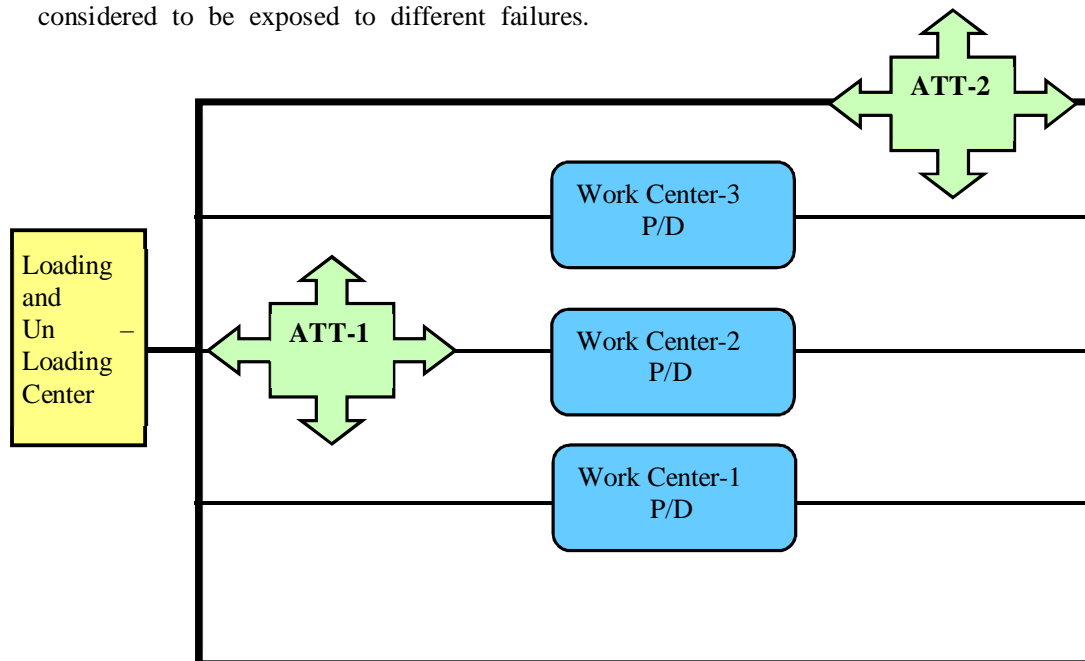

Fig. 1. An FMS model

3. Problem Description

A hypothetical FMS model operating at 3 work centers, one load/unload center, and two automatic tool transporters (ATT) is portrayed

above in Figure 1 and, also, shown in Figure 4 as run in ARENA software.

The following assumptions are considered while simulating the aforesaid FMS model in the ARENA application.

- i. The work centers (WC) and ATTs are completely reliable.
- ii. A work center will perform one operation at a time.
- iii. The machining times are deterministic in nature.
- iv. No rework is required on any job.
- v. The job type mix and release are known.

The appropriate tool selection for a production operation is a significant step for quality assurance in the production of jobs in any manufacturing system. The intelligent application of tool selection rules in the FMS is highly desirable to find and initiate transport of appropriate tools to the required work center to complete any machining operation on the job at a work center [19]. The following tool selection rules are used for their evaluation against performance parameters in the FMS.

- i. Smallest distance travel of tool transporter (SDTTT)- The tool delivery request will be taken on the basis of tool transporter traveling distance. The smallest distance value will be given priority.
- ii. Largest distance travel of tool transporter (LDTTT) - The tool delivery request will be taken on the basis of tool transporter traveling distance. The largest distance value will be given priority.
- iii. High tool life (HTL) - The tool with maximum tool life will be selected first.
- iv. Low tool life (LTL) - The tool with minimum tool life will be selected first.
- v. Highest operation completion time (HOCT) - The production operation having the highest completion time on any machine will be provided with the required tool.
- vi. Lowest operation completion time (LOCT) - The production operation having the lowest completion time on any machine will be provided with the required tool.
- vii. High material removal rate (HMRR) - The production operation with a high material removal rate on any machine will be provided with the required tool.
- viii. Low material removal rate (LMRR) - The production operation with a low

material removal rate on any machine will be provided with the required tool.

3.1. Input data and system modeling

The FMS is operating with three work-centers, two automated transporters, and one loading and unloading center. The three work centers are capable to perform any required machining operation on the jobs, i.e., if a required cutting tool is available on a work-center, job change from one work center to another is not required. The cutting tool is transferred by the ATT while moving on a path in the FMS facility and the job is transferred by using AGVs. There is no interdependence between ATTs and AGVs, i.e., both operate independently according to the production requirements. Since several new tool selection rules are introduced and the real-time industrial information and tool selection related industrial database is presently not available, the various input parameters are found by using a uniform distribution sampling process. The uniform distribution sampling is used to find the required number of operations on a particular job, associated operation times to perform an operation on a specific job and different operation sequences on the job. The FMS is considered to be operating with twelve cutting tools, which are randomly assigned for a cutting operation on a work center in the FMS. The maximum and minimum range for the number of operations is considered to be twenty and fifteen, respectively, on the different jobs under production in the FMS. The cutting operation time ranges from eight-minutes to one hundred minutes for different cutting operations on a job. The cutting tools transfer is carried out by ATT; however, the ATT is also capable of material transfer or job transfer from one work center to another. Therefore, the material transfer in the FMS is also carried out by the ATTs available for service only. The ATTs can move at different velocity levels: 3 m/sec, 5 m/sec, 8 m/sec, and 11 m/sec. Job loading time takes eight minutes, and job unloading time takes five minutes. The distance between work centers and loading and unloading station is ten meters.

The following performance measures of the FMS are considered so as to evaluate the aforementioned tool selection rules while transferring the required cutting tools to the work centers by using automatic tool transporters (ATTs) in the FMS.

- i. Makespan.
- ii. Mean work center utilization (%).
- iii. Mean ATT utilization in the FMS (%).

The simulation logic is portrayed in Figure 2 and also developed in the ARENA application, as shown in Figure 3. The simulation experimental conditions are mentioned below [20].

- i. The length of simulation experiment runs for the FMS: 1200 min.
- ii. Simulation transient phase time for the FMS: 600 min.
- iii. Total number of simulation runs for the FMS: 6
- iv. Part types in FMS: Six-part type equal mix and Random-ly generated part type.
- v. Total experiment run time for the FMS: $(600 + (6 \times 1200)) \times 2 = 16,000$ min.
- vi. Speed levels of ATTs: 3 m/sec; 5 m/sec; 8m/sec; 11 m/sec.
- vii. Number of ATTs: 2.
- viii. Simulation application: ARENA.

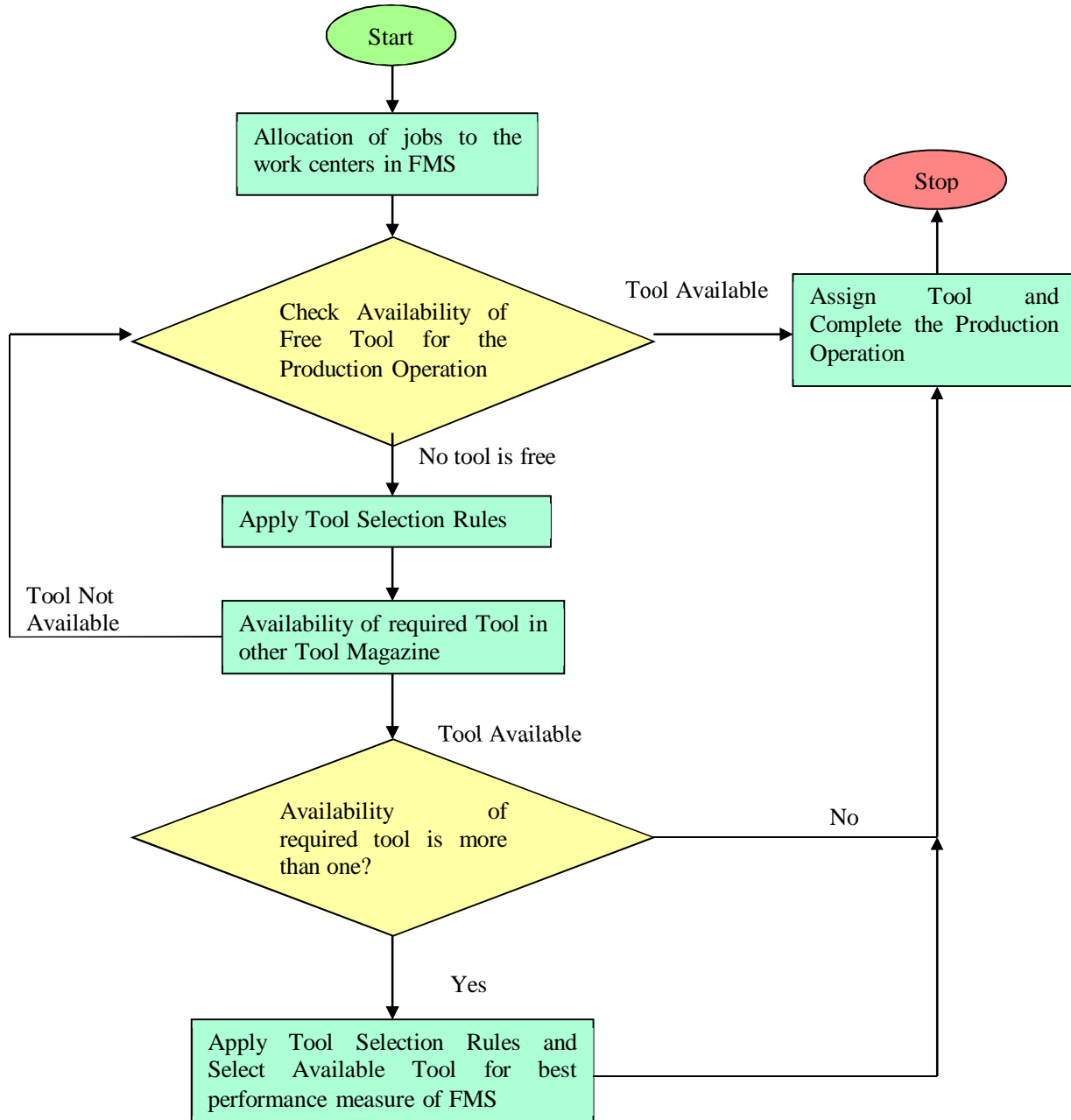

Fig. 2. The Simulation Logic

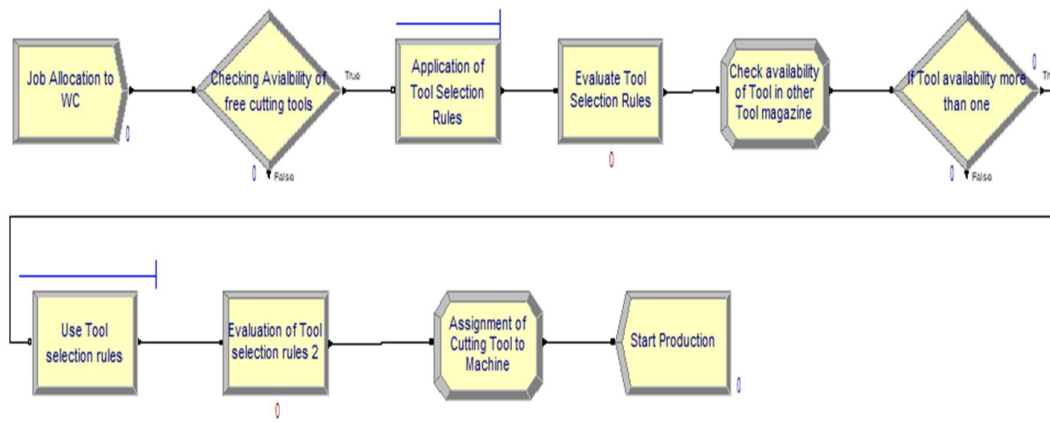

Fig. 3. Application of Tool selection rules in ARENA

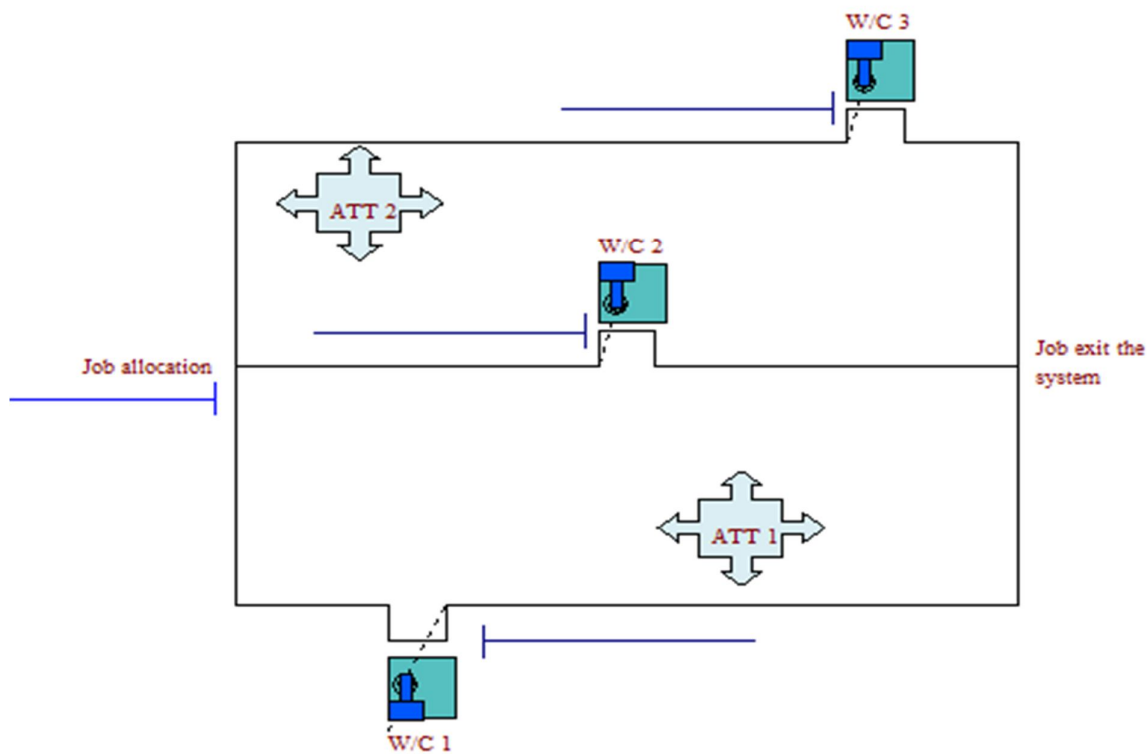

Fig. 4. FMS model in ARENA

4. Results

In order to gauge the performance of different tool selection rules against some vital FMS performance parameters, the FMS operating with three work centers, two automatic tool transporters, and one loading and unloading center is simulated in ARENA application. The FMS operates for the production of two types of part mix: six-part type of equal mix and randomly generated part type mix. The ATT speed is kept at four levels while catering tool requirements from one machining center to another in the

given FMS facility. The simulation results of makespan in FMS for the production of a six-part type of equal mix and randomly generated part type mix is tabulated in Table 1 and also shown in Figures 5 and 6, respectively. From Figures 5 and 6, it is evident that all tool selection rules offer the best results at an ATT speed of 8 m/sec, and the performance of HMRR tool selection rule yields the lowest makespan in comparison to all other tool selection rules for the production of the jobs in the FMS. However, the HMRR tool selection rule has the best performance for the production of a six-part type equal mix in the

FMS in comparison to the production of the randomly generated part type in the FMS. Similarly, the results of other performance measures, namely mean work center utilization (%) and mean ATT utilization in the FMS (%), for the production of the six-part type of equal mix and randomly generated part type mix are mentioned in Tables 2 and 3. The simulation results of mean work center utilization (%) are shown in Tables 2 and Figures 7,8 for the production of the six-part type of equal mix and randomly generated part type mix, respectively. Moreover, the simulation results of mean ATT utilization in the FMS (%) are shown in Tables 3, Figures 9 and 10 for the production of the six-part type of equal mix and randomly generated part type mix, respectively.

According to the tabulated results mentioned in Tables 2 and 3 and the plots shown in Figures 7, 8, 9, and 10, it is crystal clear that the high material removal rate (HMRR) tool selection rule yields the highest value of mean work center utilization (%) and lowest value of mean ATT utilization (%) in comparison to all other tool selection rules. According to Figures 7 and 8, it is observed that all tool selection rules offer the best results for mean work center utilization at an ATT speed of 8 m/sec, and the performance of HMRR tool selection rule yields the highest mean work center utilization in comparison to all other tool selection rules under evaluation for the production of the jobs in the FMS. From the plots shown in Figures 7 and 8, it is observed that the application of HMRR tool selection rule offers the highest mean work center utilization for the production of a six-part type equal mix in the FMS in comparison to the production of the randomly generated part type in the FMS.

The high mean work center utilization indicates the high level of the engagement of work center in the production of jobs, i.e., the work centers are busy for maximum of time, and if a work center is highly busy in the production of jobs, the cutting tool transfer requirement drops for a particular cutting operation; therefore, the mean ATT utilization is reduced while applying the HMRR tool selection rule. The plots shown in Figures 9 and 10 clearly indicate that the mean ATT utilization is minimum with the use of HMRR tool selection rule and also reduces at a high ATT speed. At a high ATT speed, the tool transfer rate increases; therefore, ATT utilization reduces in comparison to the work center utilization.

Similarly, the performance of the smallest distance travel of tool transporter (SDTTT) and high tool life (HTL) is found to be at the second and third positions (with a very minor difference), respectively, for different vital performance measures of the FMS under consideration.

From the results, it is also evident that, at a high ATT speed of 11 m/sec, the performance of all tool selection rules is observed to be the same. At a high velocity of ATT, the tool transfer operation has no significant effect on the production operations; therefore, the application of tool selection rules also becomes insignificant at the high ATT speeds. Hence, the vital performance measures of the FMS including makespan in the FMS, mean work center utilization (%), and mean ATT utilization (%) of the FMS are observed to be dependent on the ATT velocity, selection and use of appropriate tool selection rule, number of machining centers in the FMS, and the number of ATTs used for tool transfer operations in the given FMS facility.

Tab. 1. Makespan for the FMS

ATT Speed m/sec	SDTT T	LDTT T	LT L	HT L	HOC T	LOC T	HMR R	LMR R	SDTT T	LDTT T	LT L	HT L	HOC T	LOC T	HMR R	LMR R
	Six-part type equal mix in FMS								Randomly generated part type in FMS							
	Makespan (minutes)															
3	623	669	702	642	735	685	612	667	601	624	653	603	699	641	590	643
5	610	641	686	621	701	663	597	634	583	598	624	591	651	627	567	596
8	588	611	657	592	673	637	569	597	557	562	567	561	632	586	533	552
11	637	637	637	637	637	637	637	637	596	596	596	596	596	596	596	596

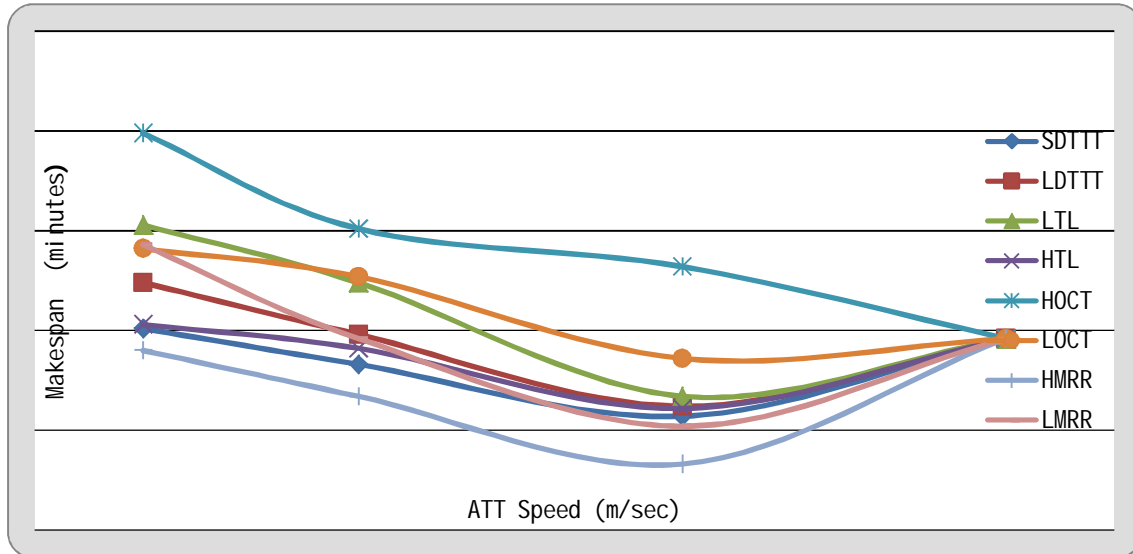

Fig. 5. Makespan (minutes) for the production of six-part type equal mix in FMS

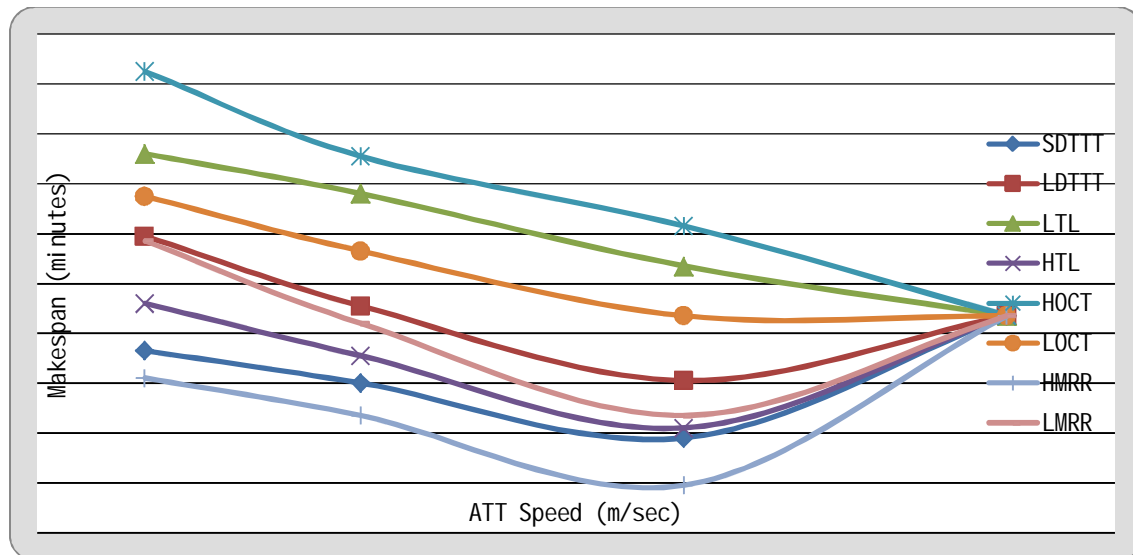

Fig. 6. Makespan (minutes) for the production of randomly generated part type in FMS

Tab. 2. Mean Work Centre Utilization (%)

ATT Speed m/sec	SDTTT	LDTTT	LTL	HTL	HOCT	LOCT	HMRR	LMRR	SDTTT	LDTTT	LTL	HTL	HOCT	LOCT	HMRR	LMRR
	Six-part type equal mix in FMS								Randomly generated part type in FMS							
	Mean Work Centre Utilization (%)															
3	51.6	46.2	46	50	46.5	51.3	52.7	47.3	48.3	41.7	41.6	47	42.2	49.2	48.1	44.2
5	52.2	48.4	48	52	47.6	53.4	54.7	50.1	50.6	42.8	43.7	48	43.8	51.7	49.6	46.5
8	54.9	51.2	51	55	51	56.7	58.1	53.2	52.8	45.7	45.2	49	47.3	52.6	53.7	49.2
11	49.6	49.6	50	50	49.6	49.6	49.6	49.6	44.1	44.1	44.1	44	44.1	44.1	44.1	44.1

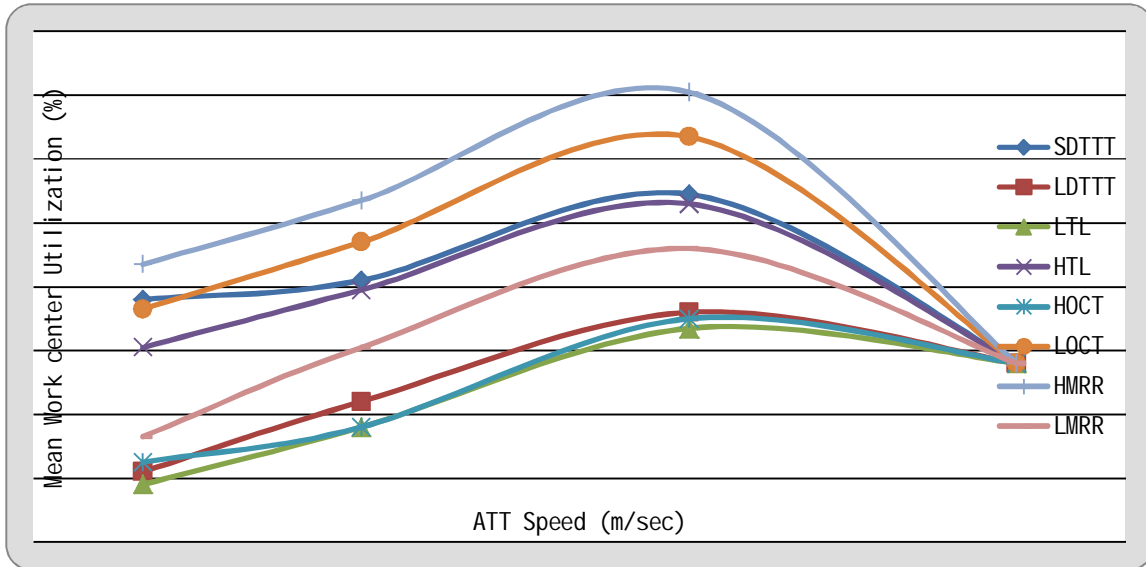

Fig. 7. Mean work center utilization % for the production of six-part type equal mix in FMS

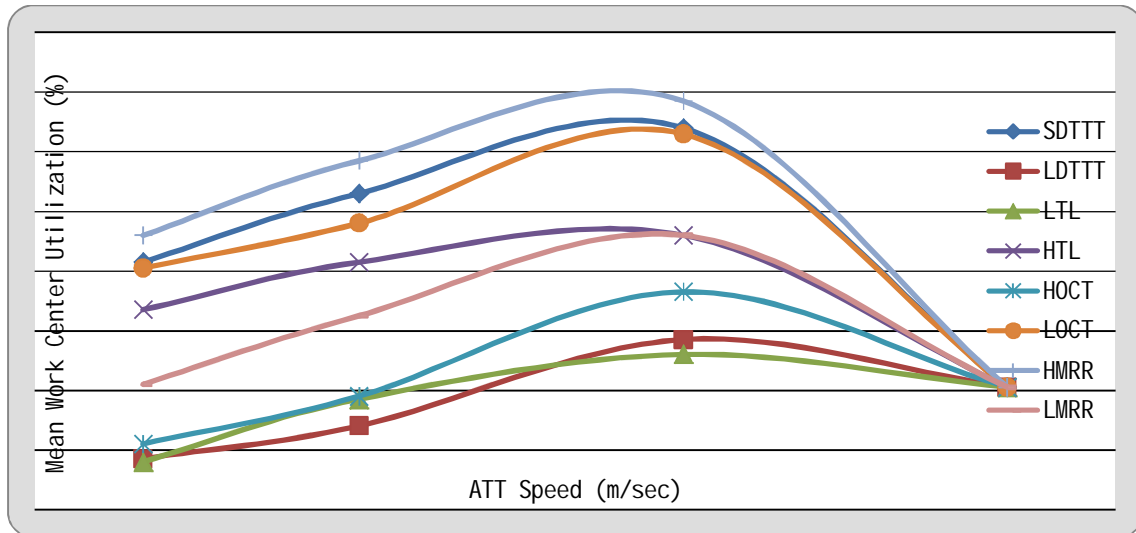

Fig. 8. Mean work center utilization % for the production of randomly generated part type in FMS.

Tab. 2. Mean ATT Utilization in the FMS (%)

ATT Speed m/sec	Six-part type equal mix in FMS								Randomly generated part type in FMS							
	SDTTT	LDTTT	LTL	HTL	HOCT	LOCT	HMRR	LMRR	SDTTT	LDTTT	LTL	HTL	HOCT	LOCT	HMRR	LMRR
	Mean ATT Utilization in the FMS (%)															
3	40.3	44.8	43	41	43.4	42.6	39.2	44.7	43.7	46.3	45.1	43	47.7	45.9	43.2	47.1
5	37.2	42.1	41	39	41.8	39.6	36.8	41.8	40.6	44.9	43.2	42	44.6	43.5	41.5	44.8
8	34.5	38.2	37	35	37.4	36.4	34.8	36.7	39.1	42.4	41.1	40	41.7	40.3	39.2	41.7
11	35.4	35.4	35	35	35.4	35.4	35.4	35.4	38.4	38.4	38.4	38	38.4	38.4	38.4	38.4

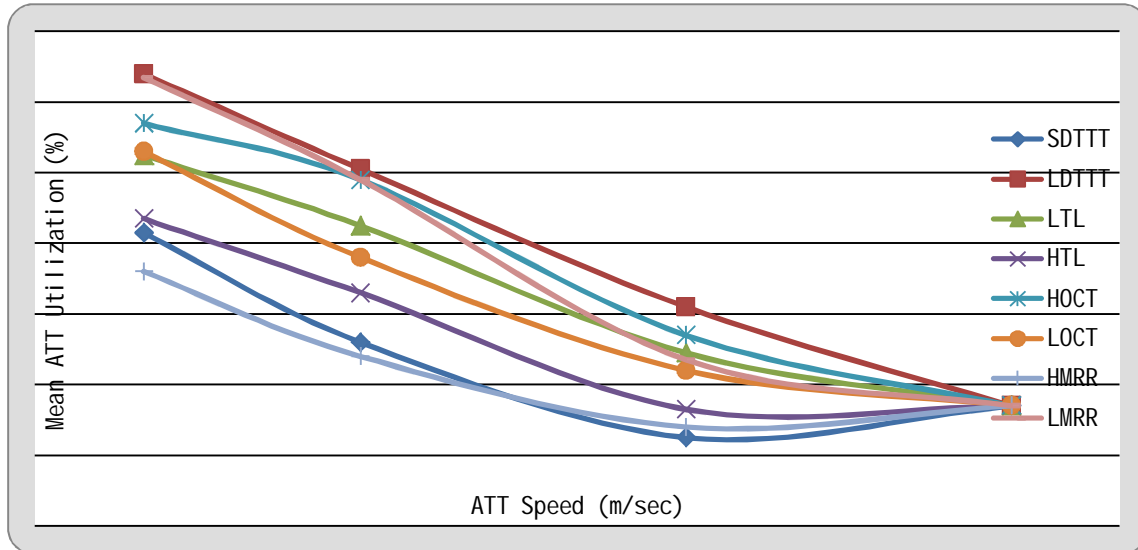

Fig. 9. Mean ATT Utilization (%) for the production of six-part type equal mix in FMS

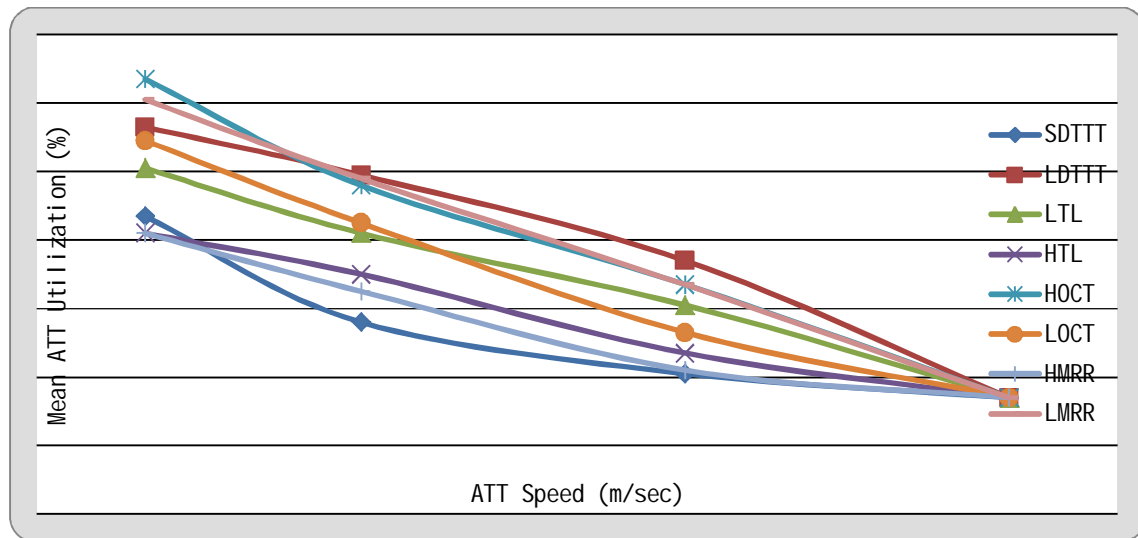

Fig. 10. Mean ATT Utilization (%) for the production of randomly generated part type in FMS

5. Conclusion

The present study focuses on gauging the effect of different tool selection rules on the performance of FMS. The FMS composed of three work centers, one loading, and unloading centers, and two automated tool transporters was modeled and simulated under eight different tool selection rules so as to find the best tool selection rule. In order to find the best tool selection rule, the makespan in FMS, mean work center utilization (%) in FMS, and mean automatic tool transporter (ATT) utilization (%) in FMS were considered as some of the performance measures of FMS. It can be concluded that the high material removal rate (HMRR) tool selection rule outperformed all other tool selection rules for the selected FMS performance measure. The application of HMRR tool selection rule yielded

the lowest value of makespan in the FMS, the highest value of mean work center utilization (%), and the lowest value of mean ATT utilization (%) in comparison to all other applied tool selection rules in the FMS.

References

- [1] Amoako-Gyampah, K., Meredith, J. R., & Raturi, A. A comparison of tool management strategies and part selection rules for a flexible manufacturing system. *International Journal of Production Research*, Vol. 30, No. 4, (1992), pp. 733-748.
- [2] Angra, S., Chanda, A., & Chawla, V. Comparison and evaluation of job selection dispatching rules for integrated scheduling

- of multi-load automatic guided vehicles serving in variable-sized flexible manufacturing system layouts: A simulation study. *Management Science Letters*, Vol. 8, No. 4, (2018), pp. 187-200.
- [3] Buyurgan, N., Saygin, C., & Kilic, S. E. Tool allocation in flexible manufacturing systems with tool alternatives. *Robotics and Computer-Integrated Manufacturing*, Vol. 20, No. 4, (2004), pp. 341-349.
- [4] Carrie, A. S., & Perera, D. T. S. Work scheduling in FMS under tool availability constraints. *International Journal of Production Research*, Vol. 24, No. 6, (1986), pp. 1299-1308.
- [5] Chanda, A., Angra, S., & Chawla, V. A Modified Memetic Particle Swarm Optimization Algorithm for Sustainable Multi-objective Scheduling of Automatic Guided Vehicles in a Flexible Manufacturing System. *International Journal of Computer-Aided Manufacturing*, Vol. 4, No. 1, (2018), pp. 33-47.
- [6] Chawla, V.K., Chanda, A., & Angra, S. Sustainable multi-objective scheduling for automatic guided vehicles and flexible manufacturing system by a grey wolf optimization algorithm. *International Journal of Data and Network Science*. Vol. 2, No. 1, (2018), pp. 27-40.
- [7] Chawla, V. K., Chanda, A. K., & Angra, S. Multi-load AGVs scheduling by application of modified memetic particle swarm optimization algorithm. *Journal of the Brazilian Society of Mechanical Sciences and Engineering*, Vol. 40, No. 9, (2018), p. 436.
- [8] Chawla, V. K., Chanda, A. K., Angra, S. & Rani, S., (2018b). Simultaneous Dispatching and Scheduling of Multi-Load AGVs in FMS-A Simulation Study. *Materials Today: Proceedings*, Vol. 5, No. 11, (2018), pp. 25358-25367.
- [9] Chawla, V., Chanda, A., & Angra, S. The scheduling of automatic guided vehicles for the workload balancing and travel time minimization in the flexible manufacturing system by the nature-inspired algorithm. *Journal of Project Management*, Vol. 4, No. 1, (2019), pp. 19-30.
- [10] Chawla, V., Chanda, A., & Angra, S. Material handling robots fleet size optimization by a heuristic. *Journal of Project Management*, Vol. 4, No. 3, (2019a), pp. 177-184.
- [11] Chawla, V. K., Chanda, A. K., Angra, S., & Rani, S. Effect of nature-inspired algorithms and hybrid dispatching rules on the performance of automatic guided vehicles in the flexible manufacturing system. *Journal of the Brazilian Society of Mechanical Sciences and Engineering*, Vol. 41, No. 10, (2019b), p. 391.
- [12] Chawla, V. K., Chanda, A. K., & Angra, S. Simultaneous workload balancing and travel time minimization of automatic guided vehicles. In *Journal of Physics: Conference Series* Vol. 1240, No. 1, (2019c), p. 012001. IOP Publishing.
- [13] Chawla, V. K., Chanda, A. K., & Angra, S. Automatic Guided Vehicle Systems in Flexible Manufacturing System—A review. *International Journal of Industrial Engineering: Theory, Applications, and Practice*, Vol. 26, No. 5, (2019d).
- [14] Dideban, A., Zareiee, M., & Orouji, A. A. Simplification of a Petri Net controller in industrial systems. *International Journal of Industrial Engineering & Production Research*, Vol. 24, No. 1, (2013), pp. 59-70.
- [15] Erol, R., Sahin, C., Baykasoglu, A., & Kaplanoglu, V. A multi-agent-based approach to the dynamic scheduling of machines and automated guided vehicles in manufacturing systems. *Applied soft computing*, Vol. 12, No. 6, (2012), pp. 1720-1732.
- [16] Gaalman, G. J., Nawjin, W. M., & Platzer, L. W. Tool sharing in an FMS—a feasibility study. *Engineering Costs and Production Economics*, Vol. 12, Nos. 1-4, (1987), pp. 107-115.
- [17] Han, M. H., Na, Y. K., & Hogg, G. L. Real-time tool control and job dispatching in flexible manufacturing systems. *International Journal of Production Research*, Vol. 27, No. 8, (1989), pp. 1257-1267.

- [18] Hosseininasab H, Kamali H R. A Hybrid Simulated Annealing algorithm for Single Row Facility Layout Problem. *International Journal of Industrial Engineering & Production Research*, Vol. 26, No. 4, (2015), pp. 243-253.
- [19] Kashyap, A. S., & Khator, S. K. Analysis of tool sharing in an FMS: a simulation study. *Computers & industrial engineering*, Vol. 30, No. 1, (1996), pp. 137-145.
- [20] Kelton, W. D. Simulation with ARENA. McGraw-hill (2002).
- [21] Kumar, N. S., & Sridharan, R. Simulation modeling and analysis of part and tool flow control decisions in a flexible manufacturing system. *Robotics and Computer-Integrated Manufacturing*, Vol. 25, Nos. 4-5, (2009), pp. 829-838.
- [22] Kumar, N. S., & Sridharan, R. Simulation-based comparative analysis of the performance of a flexible manufacturing system operating under part movement policy and tool movement policy. *International Journal of Industrial and Systems Engineering*, Vol. 9, No. 4, (2011), pp. 388-411.
- [23] Ranky, P. G. A generic tool management system architecture for flexible manufacturing systems (FMS). *Robotica*, Vol. 6, No. 3, (1988), 221-234.
- [24] Roh, H. K., & Kim, Y. D. Due-date based loading and scheduling methods for a flexible manufacturing system with an automatic tool transporter. *International Journal of Production Research*, Vol. 35, No. 11, (1997), pp. 2989-3004.
- [25] Sadaghiani, J., Boroujerdi, S., Mirhabibi, M., & Sadaghiani, P. A Pareto archive floating search procedure for solving the multi-objective flexible job-shop scheduling problem. *Decision Science Letters*, Vol. 3, No. 2, (2014), pp. 157-168.
- [26] Shah, S. A., Bohez, E. L., & Pisuchpen, R. New modeling and performance evaluation of tool sharing control in FMS using colored Petri nets. *Assembly Automation*, Vol. 31, No. 2, (2011), pp. 137-152.
- [27] Sharma, N., Chawla, V., & Ram, N. Comparison of machine learning algorithms for the automatic programming of a computer numerical control machine. *International Journal of Data and Network Science*, Vol. 4, No. 1, (2020), pp. 1-14.
- [28] Stecke, K. E., & Solberg, J. J. Loading and control policies for a flexible manufacturing system. *The International Journal of Production Research*, Vol. 19, No. 5, (1981), pp. 481-490.
- [29] Tavakkoli-Moghaddam R, Aryanezhad M, Kazemipour H, Salehipour A. A Threshold Accepting Algorithm for Partitioning Machines in a Tandem Automated Guided Vehicle. *International Journal of Industrial Engineering & Production Research*, Vol. 19, No. 1, (2008), pp. 33-42.
- [30] Udhayakumar, P., & Kumanan, S. Task scheduling of AGV in FMS using non-traditional optimization techniques. *International Journal of Simulation Modelling*, Vol. 9, No. 1, (2010), pp. 28-39.
- [31] Umar, U. A., Ariffin, M. K. A., Ismail, N., & Tang, S. H. Hybrid multi-objective genetic algorithms for integrated dynamic scheduling and routing of jobs and automated-guided vehicles (AGV) in flexible manufacturing systems (FMS) environment. *The International Journal of Advanced Manufacturing Technology*, Vol. 81, Nos. 9-12, (2015), pp. 2123-2141.

Follow This Article at The Following Site:

Chawla V, Chanda A, Angra S. Evaluation of tool selection rules in the flexible manufacturing system. *IJIEPR*. 2020; 31 (1) :131-142
 URL: <http://ijiepr.iust.ac.ir/article-1-896-en.html>

