

RESEARCH PAPER

# Spare Parts Inventory Management In the Warehouse: A Lean Approach

Rahul S Mor<sup>1\*</sup>, Arvind Bhardwaj<sup>2</sup>, Vishal Kharka<sup>3</sup> & Manjeet Kharub<sup>4</sup>

Received 25 August 2020; Revised 20 December 2020; Accepted 01 February 2021;  
© Iran University of Science and Technology 2021

## ABSTRACT

*Inventory management plays a vital role in attaining the desired service level and prevents excess capital from being tied up in the form of dead stock. This paper presents a framework to effectively determine the items subject to obsolescence in an automotive spare parts warehouse. The inventory management techniques are applied to minimize the costs and a framework is proposed based on ABC-XYZ and FSN analysis to prioritize the spare parts based on their criticality. Further, the importance of items in the warehouse is carried out to eliminate the dead stock. The ABC classification findings reveal that A-class items accounted for 10.39% and hold the highest inventory value grouping. XYZ classification concludes that much priority should be given to the management of 52.7% of items under the Z category as the demand trend of these items is highly fluctuating. The N category items have no demand in recent times and need immediate attention, thereby preventing further unnecessary procurement. Thus, based on the ABC-XYZ and FSN analysis, the non-critical items, i.e., the non-moving items having fluctuating demand, are sorted out.*

**KEYWORDS:** Spare parts; Inventory; Warehouse; Lean manufacturing; ABC, XYZ, FSN analysis.

## 1. Introduction

Lean manufacturing is an umbrella term that aims at reducing waste in manufacturing systems, and it comprises of several tools such as 5'S, Kaizen, total productive maintenance, inventory management, value stream mapping, Kanban system, etc. Inventory represents an essential asset of a business as the throughput of inventory is a primary revenue generation and subsequent earnings for each shareholder. There exist three components typically classified under the inventory account, i.e., raw materials, work-in-progress (WIP), and finished goods. Raw materials are the goods as source material. WIP comprises the goods that are under the process of

being transformed during a manufacturing practice. Finished goods relate to the products that have passed through the production process and are ready for sale. The finished products are the subject of interest in the present study. The inventory establishes a significant element of working capital in an organization. Significantly, the success or failure of an organization relies on its inventory management performances. Since inventory itself is an idle asset and involves holding cost, a minimum investment is desirable [1, 2]. Inventory management is all about how much stock of items is needed to buffer against state change in the forecast, customer demands, and supplier deliveries. Inventories are to be stored for the organization's smooth functioning without affecting the service level and customer satisfaction even if the item's demand keeps fluctuating depending on various factors, such as seasonality, the launch of a new item, market trend [3, 4]. Therefore, inventory management's main objective is to give the desired customer service level, make operations cost-efficient, and keep the inventory investment as low as possible.

\*  
Corresponding author: *Rahul S Mor*  
[rahul.ip.13@nitj.ac.in](mailto:rahul.ip.13@nitj.ac.in)

1. Dept. of Food Engineering, National Institute of Food Technology Entrepreneurship and Management, Sonapat - 131028, India.
2. Dept. of Industrial & Production Engineering, National Institute of Technology, Jalandhar, India.
3. Dept. of Mechanical Engineering, Indian Institute of Technology, Indore, India.
4. Dept. of Mechanical Engineering, CVR College of Engineering, Hyderabad, India.

Spare parts warehouse management, which is the subject of the present study's subject, provides a problematic planning aspect. On the other hand, lack of stock is associated with the risk of machine stoppage time in a sudden breakdown. Spare parts inventory of a central warehouse is significant in refining the service level and decreasing any supply chains and logistic systems' operational cost. To increase the service level and customer satisfaction and keep automobiles in operating conditions, the warehouses need to have a large safety stock. Consequently, an ample amount of money is tied up, and inventory cost is rapidly mounted. Thus, minimizing the inventory cost while exploiting the order fill rate becomes focused research now [5].

The authors presented a classification method based on the combination of FSN and VED analysis to identify the non-moving items and improve inventory management and analysis to manage inventory items effectively for raw materials [6, 7]. Software-based applications to keep the spare parts transaction records, calculate EOQ, and utilize ABC and XYZ analysis for managing the stock and clustering also improve the organization [8, 9]. Categorizing the items based on XYZ analysis leads to a 2-dimensional approach to inventory classifications that can be used more effectively [10]. Researches emphasized spare part inventory management utilizing a framework consisting of spare part grouping, demand estimation, and inventory management methods. The improved inventory control helps solve stock management and its allocation related problems [11, 12, 13]. A framework for spare parts inventory classification under 12 different classes and varying inventory models helps better forecast items in a store. An EMU coach manufacturing industry's inventory management system using FSN analysis found that the priorities of the items changes in line with different inventory analysis methods [14, 15, 16]. Authors compared various re-order point means for effective control of spare parts inventory through an oil refinery case study, focused on the importance of spare parts inventory control and challenges faced [17, 18]. The funding policies become useless given poor-quality end-of-life vehicles, whereas an optimistic impact of

sustainable supply chain (SSC) practices is observed on the economic and ecological aspects [19, 20, 21]. Studies propose an inventory control approach, i.e., ABC-fuzzy grouping, to deal with the variables of either nominal or non-nominal attributes [22]. Renewable energy cuts the carbon footprint, whereas SSC practices help improve competitiveness and organizational performance [23, 24].

The rest of the paper is organized as follows. Section 2 covers the problem formulation and methods. Section 3 presents the data collection, and section 4 is the analysis part. Section 5 includes the conclusion, limitation, and future scope of the research study.

## **2. Problem Formulation and Methods**

During the warehouse's materials department study, it is found that the inventory control policy isn't that going well with some items as the items are primarily contributing to the dead stock items, and the number of items in the dead stock list is increasing with time. Also, there is no means to maintain optimal inventory levels and decrease the overall cost. It is also observed that the inventory management list of items is not updated. Further, due to the obsolescence of technology, many spares are lying idle. Consequently, a considerable amount of assets is tied up in deadstock items. There is an increase in surplus generation in the warehouse leading to the rise in inventory holding costs. Thus, it is requisite to recognize the very critical items for continuous functioning.

### **2.1. Methodology**

#### **A. ABC analysis**

ABC analysis is a simple way of material classification regarding value and quantity based on the Pareto principle, which states that 80% of the effects come from 20% of the population. For inventory management, the Pareto principle can be interpreted as 80% of the annual investment is consumed by 20% of SKU's. According to the ABC analysis, the Stock Keeping Units (SKU's) are classified based on their Annual Usage Value [25, 26, 27, 28].

*1. A-class items:* These items are having the highest annual consumption value, and add about 70-80% of the annual consumption value of the organization, and account for only 10-20% of total inventory items.

*2. B-class items:* These items are the interclass items, i.e., having medium consumption value. B class items are 25-30% of the total inventory

items contributing to 15-25% of annual consumption.

3. *C-class items*: C-items are the items with the lowest consumption value. These institute about 50% of the total inventory items with an annual consumption value of 5%.

Steps for ABC analysis

1. Annual Usage Value (AUV) = Unit cost  $\times$  Demand
2. Arrange the items in the descending AUV.
3. The last step is item ordering based on the percentage of total inventory in terms of value and number as per the limits for A, B, and C categories.

B. XYZ analysis

The XYZ analysis is a technique to organize products in line with their variations in demand. The XYZ analysis aims to arrange the items according to their consumption to derive an optimal inventory strategy. The classification is done as follows:

1. *X class*– minimal variance: X items are characterized by almost continual, non-changing usage over the period. The demand for X class items varies slightly around a constant level to facilitate the future demand to be forecasted quite well.
2. *Y class*– some variance: The usage of Y items is neither constant nor sporadic. Some demand trends can be perceived such that seasonal fluctuations categorize the use rises or declines for a while. For these types of items, it isn't easy to get an accurate forecast.
3. *Z class*– the most variation: Z materials are not used frequently. The usage can intensely vary or occur sporadically. For these classes of items, it is common to observe periods with no consumption at all.

Steps for XYZ analysis

The XYZ analysis can be carried out using the following:

1. Mean of the set of data:  $\bar{x}$
2. Standard deviation:  $\sqrt{\frac{\sum (x - \bar{x})^2}{n}}$
3. Coefficient of variation:  $CV = \sigma / \bar{x}$

X class items: When  $CV \leq 0.5$

Y class items: When CV is in between 0.5 and 1

Z class items: When  $CV > 1$

C. FSN analysis

FSN analysis is classifying the inventory items as groups based on the rate of movement in the warehouse. The classification is given as:

1. F- Fast-moving
2. S- slow-moving
3. N- Non-moving

While performing this particular analysis, each item's average stay in the inventory has been analyzed, and accordingly, the items are sorted.

Steps for FSN classification

The average stay of an item in the inventory is calculated from the monthly average demand (MAD), the warehouse's parameter to differentiate between the fast-moving, slow-moving, and nonmoving items.

1. *F- Fast moving*:  $MAD > 1.5$ , the average stay of a fast-moving item should be less than 20 days
2. *S- Slow-moving*:  $0.33 < MAD < 1.5$ , the average stay of a slow-moving item should be in between 20 days to 3 months
3. *N- Nonmoving*:  $MAD < 0.33$ , the average stay of an item to be classified as nonmoving should be greater than three months.

## 2.2. Framework for categorization

A framework of proposed inventory classification using combined ABC-XYZ analysis and FSN analysis is shown in Fig. 1. ABC-XYZ analysis classifies the items based on annual consumption value for the demand trend. FSN analysis classifies the items as F- Fast-moving, S- Slow-moving, and N- Non-F moving, i.e., the greater is the stay of the item in inventory, the slower would be the material movement. The identification of critical and non-critical items takes place in two steps, as follows.

*Step I*: List out the items with low consumption value and high demand fluctuations using ABC-XYZ analysis (Fig. 2). The integration of XYZ to ABC classification (Fig. 3).

*Step II*: Integrate the FSN analysis to the above ABC-XYZ classification to filter out the items based on their criticality (Fig. 4). The primary purpose of using a two-step methodology is to determine the items which would most probably contribute to the list of dead stock items shortly. This would help in keeping strict control over those items which are subject to obsolescence to prevent overstocking.

**3. Data Collection**

The present study data is collected for the spare parts available in the warehouse as of September 2016. There are about 1952 spare parts in the warehouse, out of which 1039 items are active, and the remaining 913 spare parts had become obsolete. The stock value of the 913 deadstock items is found to be very high. Thus, it is observed that a huge amount of capital is tied up in the form of dead stock. The present study aims

to eliminate the dead stock by controlling the procurement of items least important from the warehouse's point of view. The present study presents a framework for identifying the 1039 active items to identify the items subject to obsolescence and prevent them from going into the dead stock by controlling their procurement. The necessary data, such as the unit cost, number of items in stock, and the demand trend, are collected for the 1039 items.

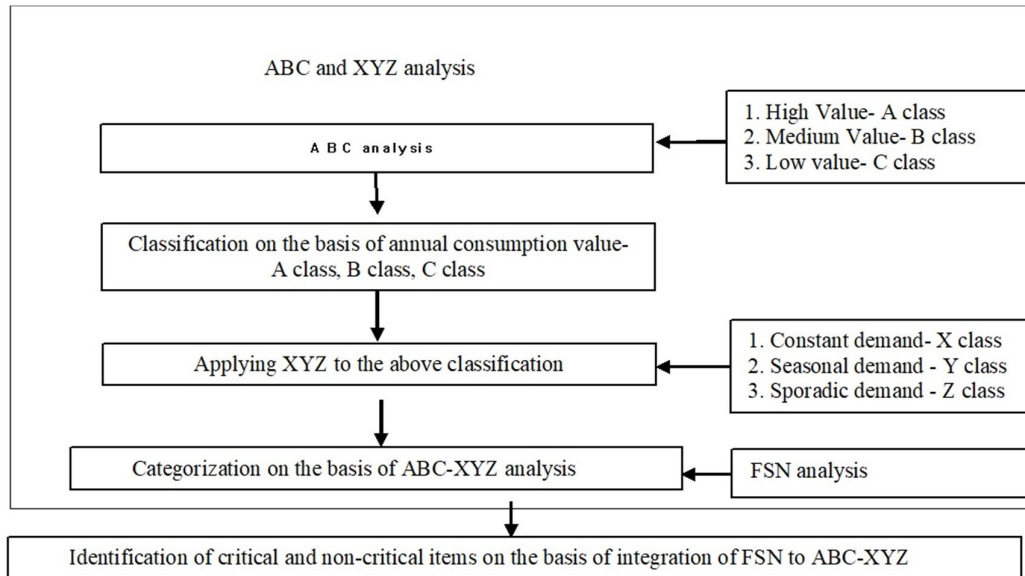

**Fig. 1. Framework for categorization**

	A	B	C
X	High-value percentage Continuous demand High predictive Value	Average Value Percentage Continuous demand High predictive Value	Low-value Percentage Continuous demand High predictive Value
Y	High-value percentage Fluctuating Demand Average Predictive Value	Average Value Percentage Fluctuating Demand Average Predictive Value	Low-value Percentage Fluctuating Demand Average Predictive Value
Z	High-value percentage Irregular Demand Low Predictive value	Average Value Percentage Irregular Demand Low Predictive value	Low-value Percentage Irregular Demand Low Predictive value

**Fig. 2. ABC-XYZ classification**

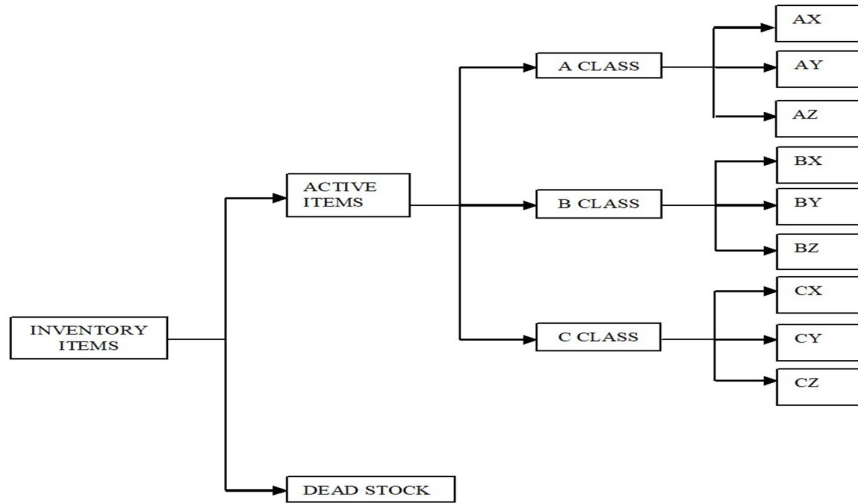

Fig. 3. Integrating XYZ to ABC classification

Classification based on Integration of FSN to ABC-XYZ	Criticality
AY-F, AZ-F, BY-F, BZ-F	High
AX-F, AX-S, AY-S, AZ-S, AX-N, AY-N, AZ-N, BX-N, BX-F, BX-S, BY-S, BZ-S, CX-F, CY-F, CZ-F, CX-S, CY-S	Medium
BY-N, BZ-N, CX-N, CY-N, CZ-S, CZ-N	Low

Fig. 4. Criticality based on two-step methodology

4. Analysis

A. ABC classification

Under ABC analysis, 108 items are found to be in A-category, accounting for 10.39%. These items have the highest inventory value grouping. This is followed by 277 items in B-category, accounting for 26.6% of the items. The rest 654 items fell in the C category and accounted for about 62.9% of the entire lot (Table 1). Here, the items with the highest economic impact on inventory can be determined and considered for needful action.

The safety stock levels of ‘A’ class items desire to be revised intermittently and should be retained as low as possible. Though, before skipping to the conclusions, one needs to interact with the respective users of ‘A’ class items to know their critical facets. After this, the ‘B’ class items must be considered, and stock levels need to be revised. The ‘C’ category items with a minimum influence on total inventory value need no revision as frequently as ‘A’ class items [26].

Tab. 1. Results for ABC analysis

Class	Percentage of items	Percentage of Annual usage Value	Consumption
A	10.39%	75%	High
B	26.6%	20%	Medium
C	62.9%	5%	Low

B. XYZ Classification

The XYZ classification is done based on demand fluctuations (Table 2), and out of 1039 items, 21.6% items are under X class, 25.7% items under Y class, and 52.7% items under Z class (Table 3). Much priority should be given to

manage 52.7% of items under the Z-category as the demand trend of these items is highly fluctuating. An inefficient management policy for Z class items will lead to the stacking up of items in the warehouse [9, 10].

**Tab. 2. Basis for XYZ analysis**

Class	Coefficient of Variation	Fluctuations in demand
X	$CV \leq 0.5$	Low
Y	$0.5 < CV \leq 1$	Medium
Z	$CV > 1$	High

**Tab. 3. Percentage Items in XYZ classification**

Class	Percentage of items	Fluctuations in demand
X	21.6%,	Low
Y	25.7%	Medium
Z	52.7%	High

### C. ABC-XYZ classification

The items are grouped according to their value and the fluctuations in demand into nine different groups. Different management policies are adopted for the items under different groups (Fig. 2). The integration of ABC-XYZ analysis results in the sorting of spare parts based on the fluctuation in demand and average annual usage,

thus filtering out the items with low value- high fluctuation in demand, which is the warehouse's problematic items' point of view [9]. The results show that the CZ class of items contributes to 81% of Z class items, followed by BZ contributing about 18% and 1% by the AZ items shown in Table 4.

**Tab. 4. Z Class items based on ABC-XYZ**

Class	Percentage of items	Characteristics	Criticality
AZ	1%	High Value- High fluctuation in demand	High
BZ	18%	Medium value- High fluctuation in demand	Medium
CZ	81%	Low value- High fluctuation in demand	Low

### D. FSN classification

FSN analysis is carried out on the spare parts to know about the usage patterns since the ABC-XYZ analysis does not consider the movement rate of items in the warehouse. FSN analysis is the classification based on the consumption pattern and the rate of movement of items. It is necessary to sort out the items whose demand is very less and be termed as non-moving items to control obsolescence (Table 5). The analysis showed that 379 items are fast-moving, 458 items came under the slow-moving category, and the

remaining 179 items came under the non-moving category (Table 6). Since the N category items have no demand in recent times due to the change in market trend or other factors, these parts require immediate attention to how these can be eliminated, because stocking them can increase the holding costs and prevent further unnecessary procurement of these items. Thus, based on the ABC-XYZ and FSN analysis, the non-critical items, i.e., the non-moving items having fluctuating demand, are sorted out [7, 16].

**Tab. 5. Basis for FSN analysis**

Class	Monthly Average Demand	Characteristics	Criticality
F	$MAD \geq 1.5$	Fast-moving	High
S	$0.33 < MAD < 1.5$	Slow-moving	Medium
N	$MAD \leq 0.33$	Non-moving	Low

Tab. 6. Results for FSN analysis

Class	Percentage of items	Characteristics	Criticality
F	36.5%	Fast-moving	High
S	44%	Slow-moving	Medium
N	19.5%	Non-moving	Low

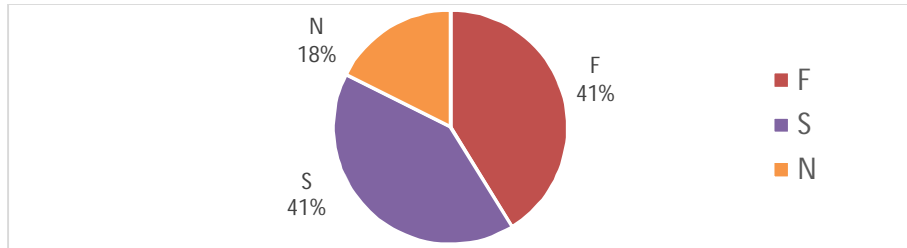

Fig. 5. Integration of FSN to ABC-XYZ classification

The ABC-XYZ analysis shortlisted the spare parts based on annual average value and fluctuations in demand. The FSN analysis is a classification based on their movement in the warehouse. The criticality of items based on the integration of ABC-XYZ with FSN analysis (Fig. 4).

#### E. Identifying the items subject to obsolescence

In the present study, the objective has been to identify the least essential items from the warehouse's point of view and develop a method to identify the items subject to obsolescence and control their procurement. From the ABC-XYZ classification, it is found that the CZ category contributes to the majority of Z class items, i.e., 81% of Z class items. And the FSN analysis showed that the CZ class of items contributed to the majority of non-moving items. It is found that the non-moving items add up to 13% of the stock value in the warehouse (Fig. 6). The non-moving item's value comprised 31% of CZ class of items, 33% of items that had become obsolete, and 36%

of all other items in terms of stock value shown in Fig. 7. So it can be concluded that to prevent dead stock in the future, CZ-N procurement must be checked. Based on the framework and analysis, the items under CZ-N can be termed as the items subject to obsolescence as they are at risk of becoming obsolete soon [25]. The items under CZ-N have a low value, non-moving, and high fluctuating demand trend; thus, they contribute very less to the revenue generation than a-class and B-class items. However, an eye should be kept on the CZ-S class too, as procuring these items in excess amount can be risky for the changing market trend and may soon add up to the list of CZ-N class and finally to the dead stock list. This two-step analysis of ABC-XYZ and FSN analysis reveals that the CZ-N and CZ-S class of items require proper control, failing to which these items will add up to the obsolete list items soon. Avoiding or eliminating the CZ-N class items from the warehouse will upsurge the space accessibility, diminishing the inventory holding cost to reduce the warehouse's deadstock (Fig. 8).

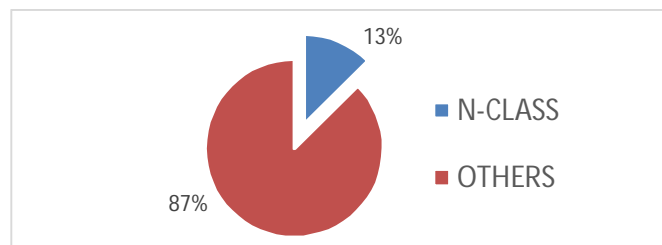

Fig. 6. Stock value of Non-moving items

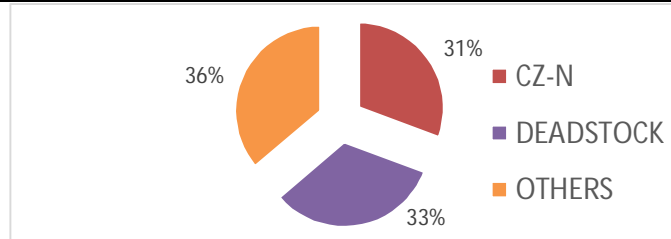

Fig. 7. Breakdown of Non-moving items



Fig. 8. Flow of items into dead stock

### F. Surplus identification

Based on the two-step analysis, it is found that 93 items came under CZ class, 72 items are on the verge of being obsolete, while the remaining 14 items are of different classes. The findings suggest that since the 93 items came under the CZ-N class, i.e., Non-moving low-value items with high fluctuations in demand, these items

should not be stocked in the warehouse. For 72 items whose demand is almost null in the recent market, arrangements should be made to sell off the items to other vendors before the items become obsolete. The pie chart contributes to the stock value of CZ-S, CZ-N class, and deadstock items (Fig. 9).

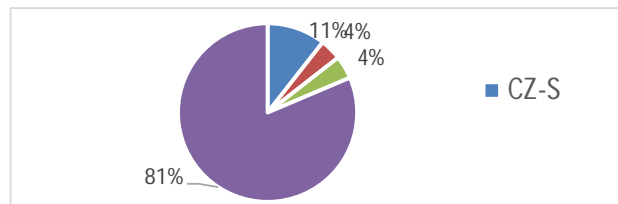

Fig. 9. Stock value of CZ-S, CZ-N and dead stock items

### G. Financial benefit accrued to implementation

The spare parts under the CZ-N class of items should not be stocked in the warehouse as they are the least critical items and as they have a high fluctuation in demand, their forecasting is not convenient. Then CZ-S class of items should be carefully procured as they can make to the list of CZ-N and eventually to the dead stock soon. The warehouse at present stocks about 93 CZ-N parts

and 72 items whose demand is almost zero according to recent market trends. The stock value of these items adds significant value. Proper elimination and liquidating procedures or even clearance discounts would recover a major portion of the surplus stock as managing these items in the warehouse for a longer period will eventually result in higher holding costs.

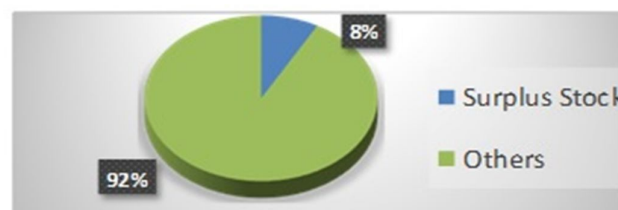

Fig. 10. Share of surplus stock out of total stock value



The money thus recovered could thus be invested in the efficient procurement of high-value critical items, which will significantly improve the warehouse's service level. The share of surplus stock (CZ-N and Deadstock items) in the total stock is shown in Fig. 10.

## 5. Conclusion

There lies a huge emphasis on utilizing the resources properly through managing inventory levels in today's competitive environment. The problem lies in determining the appropriate levels of inventory. Though high inventory levels, it increases the customer service level but holds the valuable working capital in surplus inventory. Also, carrying fewer inventories infers an increase in the risk of stock-outs and lost sales. Thus, organizations need to carry the requisite amount of inventory in their stocks. The conclusions of this study are as follows. Firstly, many selective inventory techniques such as ABC, FSN, HML, and so on are being utilized to classify items based on their priority. The aim is to maintain an impressive service level and optimize inventory management by minimizing inventory costs. Secondly, in the present study, a framework is proposed based on ABC-XYZ and FSN analysis to prioritize the spare parts based on their criticality. The framework also identifies the problematic items from the warehouse's point of view and the surplus stock that can be disposed-off. Based on the categorization, effective inventory policies can be employed based on the warehouse's objectives. Thirdly, this study aims to eliminate the dead stock by determining the problematic items and the least important items in the warehouse. In this way, investments can be made in the procurement of items, which are primary revenue generators for the organization. This study will help manage the inventory items and reduce the inventory holding costs by effectively disposing of the items subject to obsolescence. This approach will primarily be helpful against buying unnecessary spare parts, thereby utilizing the resources efficiently. Therefore, the inventory should be analyzed periodically as per the priority and criticality list.

### 5.1. Limitations and future scope

The proposed framework identifies the problematic items and eliminates the dead stock; further studies can be done to develop a framework using VED, HML, etc., for more effective classification. Further, to adopt the proposed framework for identifying critical items, a periodic review of the items is mandatory to track the demand trend followed by a newly

introduced item in the inventory. Further research can be done to incorporate the framework to their existing 'TOPSERVE' module, or a separate working module can be developed for effective and instant classification of the items based on their criticality.

## References

- [1] Kumar, S., Dhingra, A. K., & Singh, B. Implementation of the lean-kaizen approach in fastener industries using the data envelopment analysis. *Facta Universitatis, series: Mechanical Engineering*, Vol. 15, No. 1, (2017), pp. 145-161.
- [2] Indrajitsingha, S.K., Samanta, P., Raju, L.K. and Misra, U. Two-storage inventory model for deteriorating items with price dependent demand and shortages under partial backlogged in fuzzy approach. *LogForum*, Vol. 15, No. 4, (2019), pp. 487-499.
- [3] Mor, R.S., Nagar, J., & Bhardwaj, A. A comparative study of forecasting methods for sporadic demand in an auto service station. *International Journal of Business Forecasting & Marketing Intelligence*, Vol. 5, No. 1, (2019), pp. 56-70.
- [4] Accorsi, R., Bortolini, M., Ferrari, E., Gamberi, M. and Pilati, F. Class-based storage warehouse design with diagonal cross-aisle. *LogForum*, Vol. 14, No. 1, (2018), pp. 101-112.
- [5] Mladenović, S., Milosavljević, P., Milojević, N., Pavlović, D., & Todorović, M. The path towards achieving a lean six sigma company using the example of the Shinwon company in Serbia. *Facta Universitatis, Series: Mechanical Engineering*, Vol. 14, No. 2, (2016), pp. 219-226.
- [6] Vaisakh, P.S., Dileepal, J. & Unni, N. Inventory management of spare parts by combined FSN and VED analysis. *International Journal of Engineering and Innovative Technology*, Vol. 2, No. 7, (2013).
- [7] Kumar, Y., Khaparde, R.K., Dewangan, K., Dewangan, G.K., Dhiwar, J.S., &

- Sahu, D. FSN analysis for inventory management- case study of sponge iron plant. *International Journal for Research in Applied Science & Engineering Technology*, Vol. 5, No. 2, (2017), pp. 53-57.
- [8] Mohd-lair, N., Muhiddin, F., Laudi, S., Mohd-Tamiri, F., & Chua, B. The spare part inventory management system (SPIMS) for the profound heritage SDN BHD: a case study on the EOQ technique. *International Journal of Research in Engineering & Technology*, Vol. 2, No. 1, (2014), pp. 7-14.
- [9] Bulinski, J., Waszkiewicz, C., & Buraczewski, P. Utilization of ABC/XYZ analysis in stock planning in the enterprise. *Annals of Warsaw University of Life Sciences-SGGW. Agriculture*, Vol. 61, (2013), pp. 89-96.
- [10] Dhoka, D.K., & Choudary, Y.L. XYZ inventory classification & challenges, *IOSR Journal of Economics and Finance*, Vol. 2, No. 2, (2013), pp. 23-26.
- [11] Wahba, E.M., Galal, N.M., & El-Kilany, K.S. Framework for Spare Inventory Management. *International Journal of Social, Behavioral, Educational, Economic, Business and Industrial Engineering*, Vol. 6, No. 11, (2012), pp. 2220-2227.
- [12] Ravichandran, N. A study on inventory management with reference to leading automobile industry. *International Journal of Management, Information Technology and Engineering*, Vol. 2, No. 5, (2014), pp. 15-28.
- [13] Mor, R.S., Bhardwaj, A., Singh, S., & Sachdeva, A. Productivity gains through Standardization-of-Work: Case of Indian manufacturing industry. *Journal of Manufacturing Technology Management*, Vol. 30, No. 6, (2019), pp. 899-919.
- [14] Bacchetti, A., & Saccani, N. Spare parts classification and demand forecasting for stock control: Investigating the gap between research and practice. *Omega*, Vol. 40, No. 6, (2012), pp. 722-737.
- [15] Mahootchi, M., Ahmadi, T., & Ponnambalam, K. Introducing a new formulation for the warehouse inventory management systems: with two stochastic demand patterns. *International Journal of Industrial Engineering & Production Research*, Vol. 23, No. 4, (2012), pp. 277-284.
- [16] Mitra, S., Reddy, M. S., & Prince, K. Inventory control using FSN analysis—a case study on a manufacturing industry. *Int. J. Innovative Sci. Eng. Technol*, Vol. 4, No. 2, (2015), pp. 49-55.
- [17] Porras, E., & Dekker, R. An inventory control system for spare parts at a refinery: An empirical comparison of different re-order point methods. *European Journal of Operational Research*, Vol. 184, No. 1, (2008), pp. 101-132.
- [18] Jin, T., & Liao, H. Spare parts inventory control considering stochastic growth of an installed base. *Computers & Industrial Engineering*, Vol. 56, No. 1, (2009), pp. 452-460.
- [19] Yu, Z., Tianshan, M., & Khan, S. A. R. Investigating the effect of government subsidies on end-of-life vehicle recycling. *Waste Management & Research*, 0734242X20953893, (2020).
- [20] Khan, S. A. R., Yu, Z., Sharif, A., & Golpîra, H. Determinants of economic growth and environmental sustainability in South Asian Association for Regional Cooperation: evidence from panel ARDL. *Environmental Science and Pollution Research*, Vol. 27, No. 36, (2020), pp. 45675-45687.
- [21] Khan, S. A. R., Yu, Z., Golpîra, H., Sharif, A., & Mardani, A. A state-of-the-art review and meta-analysis on sustainable supply chain management: Future research directions. *Journal of Cleaner Production*, 123357, (2020).

- [22] Chu, C.W., Liang, G.S., & Liao, C.T. Controlling inventory by combining ABC analysis and fuzzy classification. *Computers & Industrial Engineering*, Vol. 55, No. 4, (2008), pp. 841-851.
- [23] Nathaniel, S., & Khan, S. A. R. The nexus between urbanization, renewable energy, trade, and ecological footprint in ASEAN countries. *Journal of Cleaner Production*, Vol. 272, (2020), p. 122709.
- [24] Rehman Khan, S. A., & Yu, Z. Assessing the eco-environmental performance: an PLS-SEM approach with practice-based view. *International Journal of Logistics Research and Applications*, (2020), pp. 1-19.
- [25] Cobbaert, K., & Van Oudheusden, D. Inventory models for fast moving spare parts subject to “sudden death” obsolescence. *International Journal of*
- Production Economics*, Vol. 44, No. 3, (1996), pp. 239-248.
- [26] Grondys, K. ABC analysis in spare parts warehouse. *Polish Journal of Management Studies*, Vol. 3, No. 1, (2009), pp. 147-156.
- [27] Yang, K., & Niu, X. Research on the spare parts inventory. *IEEE 16<sup>th</sup> International Conference on Industrial Engineering and Engineering Management*, (2009), pp. 1018-1021.
- [28] Fakhrzad, M. B., & Mohagheghian, E. A Game Theory Approach to Multi-Period Planning of Pricing, Ordering, and Inventory Decisions for a Make-to-Order Manufacturing Supply Chain. *International Journal of Industrial Engineering & Production Research*, Vol. 30, No. 1, (2019), pp. 105-115.

Follow This Article at The Following Site:

Mor R S, Bhardwaj A, Kharka V, Kharub M. Spare parts inventory management in warehouse: a lean approach. *IJIEPR*. 2021; 33 (2) :1-11  
URL: <http://ijiepr.iust.ac.ir/article-1-1110-en.html>

