



Design and implementation of Mobile Robot for Fire Fighting Using Photovoltaic Panel with Artificial Intelligent

Rawaa Jawad*, Raheel Jawad ^{**}(C.A.)

Abstract: Fire accidents are a disaster that can cause loss of life, property damage and permanent disability to the affected victim. Firefighting is a very important and dangerous job. Firefighters must extinguish the fire quickly and safely to prevent further damage and destruction. Detecting and extinguishing fires is a dangerous task that always puts the lives of firefighters at risk. One of the most effective tools for early fire extinguishing is the firefighting robot. Fire sensing in most industries is absolutely essential to prevent catastrophic losses. Robots with this type of embedded system can save the lives of engineers in industrial sites with hazardous conditions. This project aims to design and implement a solar-powered with artificial intelligent of mobile fire detection robot to detect fires in disaster-prone areas and thus reduce human work effort and level of destruction. Design a robot capable of moving using a rotary motor, finding a flame using a flame sensor, and extinguishing a fire using a water spray using a pump, all of which is controlled by an Arduino Uno microcontroller and programmed using an artificial intelligence (fuzzy) logic technology) using MATLAB, the inputs It has two variations:: flame and gas with three organic functions, each of which has a gas variable (low, medium, high), flame sensor (small, normal, large), and the output is a pump, (pump off , pump on) with 9 rules. In addition to the experimental setup of the proposed system which demonstrates the performance of sensors (gas, flame) using fuzzy and implemented logic tools. The performance of the solar panels was first tested using MATLAB software as well as experimentally under different weather conditions. The pump's performance is being tested experimentally, and the robot is also being tested to detect and extinguish fires. The process of designing and implementing robotics involves creating mechanical and electrical systems. The results showed the effect of temperature change on the solar panel, as when it increases, the panel's production capacity decreases, as well as the effect of decreased solar radiation resulting from clouds and other things, and the extent of its effect. Impact on the performance efficiency of solar panels, and observing the pump performance in terms of flow rate and height. Hence, it can be noted that the robot designed in the project is capable of discovering fire sources and extinguishing them using fire-fighting systems equipped with a water tank and a controllable pump to spray the water necessary for the process. From this study, can be concluded that the designed model is able to work according to its initial design with artificial intelligence with the least amount of errors, and therefore it can be applied in industrial applications, avoiding fire damage and extinguishing it when it occurs for the first time.

Keywords: Robot, Solar Cell, Fire, Detection, Flame Sensor, Fuzzy Logic.

1 Introduction

THE development of a solar-powered firefighting robot has become an attractive factor for startup companies. With the aim of using solar cells to recharge [1], these robots soon began to play an important role in

various sectors [2]. With solar panel installations rising rapidly over the past few years, the total electricity produced by solar energy has increased rapidly. The rapid rise of a zero-emission energy source is beneficial to our planet in many ways, so applying solar panel technology to [3] firefighting robots is important to avoid loss of life and property and extinguish fire quickly and safely to prevent further damage and destruction. Detecting and extinguishing fires is a dangerous task that always puts the lives of firefighters at risk. Fire sensing in most industries is absolutely essential to prevent catastrophic losses. Robots with this type of built-in system can save the lives of engineers in industrial sites with hazardous conditions [4]. There are

Iranian Journal of Electrical & Electronic Engineering, 2024.

Paper first received 18 June 2024 and accepted 23 July 2024.

* The author is with the Electrical Engineering Department, University of Technology, Baghdad – Iraq.

** The author is with the Electromechanical Engineering Department, University of Technology, Baghdad – Iraq.

E-mails: eme.51262@uotechnology.edu.iq

Corresponding Author: Raheel Jawad.

many researchers study the firefighting robot with different ways and techniques such as: **A Eswaran, Fellow (2018) [5]** A firefighting robot designed and controlled remotely to spray water through a PLC. **BareraSarwar (2018) [6]** The fire detection system was designed based on Fuzzy Logic and warning system that also sends a message by sending an alert using Global Mobile communication technology system (GSM). **J. NavyaSree, et. el (2023) [7]** A robot was designed to put out fires by relying on smoke and fire sensors to pump water over the flames.

This study revolves around designing a robot to extinguish fires using artificial intelligence techniques and solar panels for saving energy and a long time permanently by replacing smoke detectors with infrared flame sensor as used in smart systems and provide a reliable and cost-effective fire security system and works all the time. So can be applied in different areas such as residential, commercial, as well as industrial applications. It is more applicable in areas where there is high potential for fire and where there are smoke detectors and fire extinguishing system.

2 Photovoltaic cell

Photovoltaics (PV) and renewable energy sources have witnessed great development in recent years [8-10]. Current photovoltaic technology has been well developed since 1941. Photovoltaic (PV) panels are used to generate electricity via semiconductors that convert solar radiation into electricity without using any heat engine. At least two layers of semiconducting material, one with a positive charge and the second with a negative charge, constitute a photovoltaic cell. The semiconductor atoms on the surface direct part of the photons absorbed from the sun's rays, which leads to the liberation of the electrons in the cells. One of the advantages of solar energy is that it is clean, sustainable, free, and provides electricity to remote places, but it requires part-time work, less efficiency, and expensive equipment. Its reliability on the site and the environmental impact of producing photovoltaic cells, so the components of the photovoltaic system consist of five main components: solar panel, regulator, battery, AC converter (inverter, electricity load).[12-13] Finally, the use of photovoltaic energy technology has become an alternative solution that can It is relied upon in many applications, including pumping systems, outer space, the production of large amounts of electrical energy that feeds the network directly, terrestrial communications, protection and safety devices in civil and military alerts and warning systems, and marine uses. It provides the necessary energy for lighting, visual guidance, and surveillance devices. [14-15]. A Solar Panel using in propose system is 5.5W and its specification shown in

Table (1).

Table 1 Specification Photovoltaic cell	
Feature	Specification
Cell Type	Mono Crystalline Silicon, Photo Voltaic Solar Cells
Dimension of Module (mm)	300 x 210 x17
Open-Circuit Voltage (V_{OC})	22.0V
Short-Circuit Current (I_{SC})	0.31A
Voltage at P_{MAX} (V_{MP})	17.6V
Current at P_{MAX} (I_{MP})	0.28A

2.1 Mathematical Equation of Photovoltaic Panel

PV module is the basic unit of power PV generation system. PV module has non-linear characteristics which depend on solar radiation and cell temperature. The parameters of PV module that is employed in this study are defined in equations (1) and (2)[16].

$$I = I_{ph} - I_{rs} \left[\exp\left(\frac{V+I R_S}{aV_T}\right) - 1 \right] \quad (1)$$

Where:

$$V_T = \frac{N_S k T_c}{q} \quad (2)$$

The output powr is [17]:

$$P_m = I_{max} V_{max} \quad (3)$$

Fill factor (FF) represents the ratio of maximum power divided by the open circuit voltage and short circuit current [17]:

$$F.F = \frac{P_m}{P_{th}} = \frac{V_{max} I_{max}}{V_{oc} I_{sc}} \quad (4)$$

I , I_{ph} and I_{rs} are the output, photo-generated and the diode saturation currents respectively, V is the output voltage, R_S is the series resistance, N_S is the number of cells, V_T is the junction thermal voltage, A is the ideality factor, k is the Boltzman constant ($1.3806503 \times 10^{-23}$ J/K), T is the cell temperature and q is the electron charge ($1.6021765 \times 10^{-19}$ C).

3 Fire Fighting Robot

A robot is a system that combines software, power supply, manipulators, control systems, and sensors to carry out a task. Physics, mechanical, electrical, structural, mathematical, and computer sciences are all used in the design, construction, programming, and testing of robots. [18-20].

3.1 Advantage of Fire fighter Robot

- Firefighters are less likely to encounter hazardous circumstances when there are robots around.
- Firefighters' workload decreased.
- In a major disaster, it is impossible to put out a fire and save a large number of victims at once.
- Those could be devices with remote controls.

- The vehicle can reach a position that firefighters cannot, such as petrochemical complexes and big warehouses fire.
- Robotics can function via itself [21-22].

4 Artificial Intelligence Techniques

The field of artificial intelligence (AI) has advanced greatly in the last several years. It is a fruitful field of study with a growing number of significant studies and basic technology domains and application areas. In addition to algorithmic advancements. Artificial intelligence's capacity to handle large amounts of data, complexity, high precision, and processing speed is being leveraged to advance the sciences and technologies [23].

Artificial Neural Networks (ANNs), Fuzzy Logic (FL), Genetic Algorithm (GA), Neuro - Fuzzy Interference System (ANFIS), Particle Swarm Optimization (PSO), and other well-known artificial intelligence tools are used in a variety of fields, including engineering, science, medicine, computing, finance, and economics [24].

4.1 Fuzzy Logic System

Zadeh first presented fuzzy logic in 1965, and it was founded on the idea of fuzzy sets. The major instrument for analyzing uncertainty is the theory of probability, which also assumes that uncertainty is a random process. The theory of fuzzy sets gives a means of describing uncertainty. Uncertainty, however, is not entirely random. The necessity to handle an enormous number of options is the fundamental issue with the robot's journey. Fuzzy logic has the benefit of allowing complex systems to be described with common sense. The system can be simplified by defining a set of input and output variables and use fuzzy logic to create a basic rule-based matrix. The components that comprise the fuzzy system are as follows: input fuzzification and a rule-based (a set of If – Then rules) for membership function of each input and defuzzification for outputs [25-29] as shown in Fig. (1) Fuzzy logic system.

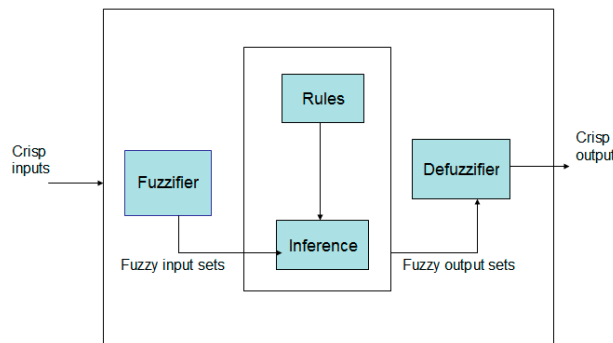

Fig.1 Fuzzy Logic System.

FLS structure is illustrated as shown in Fig. (2) the Mamdani model system is used in this study, for two inputs and one output and in fuzzification stage the pump is output, and membership functions are defined for the gas and flame input variables. The degree of truth in each rule's premise is ascertained by applying the membership functions established on the input variables to the actual values of the input variables. The membership function for gas variable is low, medium, and high, also the flame sensor is small, normal, and large, as well as the output is the open pump as the pump off, pump on is the membership function that shown in Fig. (3a, b, c).

In order the fuzzy rule base IF-THEN 9 rules are generated that shown in Table (2) for each variables flame, and gas.

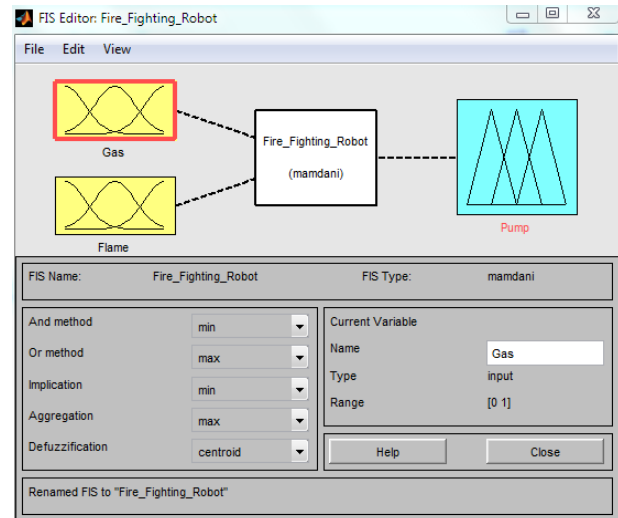

Fig. 2 Structure of fuzzy logic system

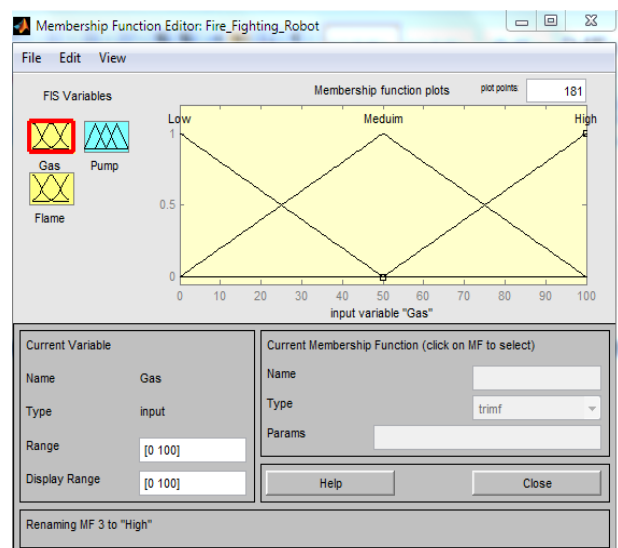

Fig. 3a The membership function of input gas sensor.

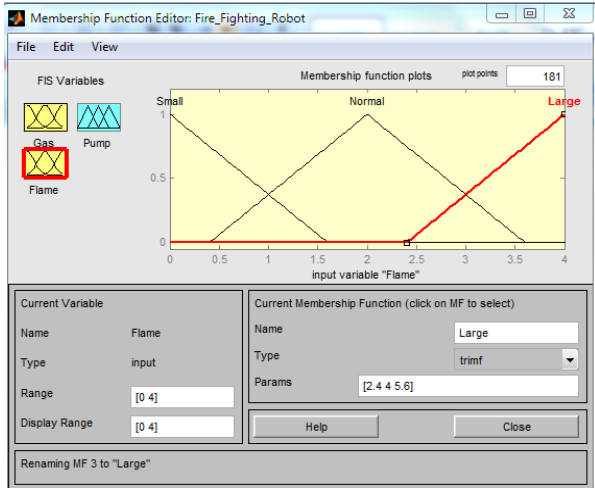

Fig 3b The membership function of input flame sensor.

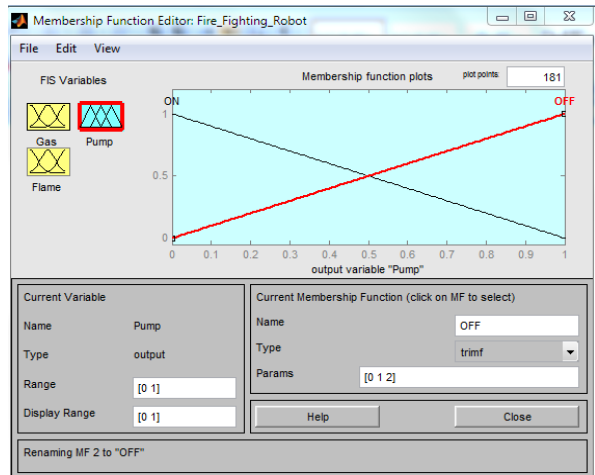

Fig. 3c The membership function of output pump.

Table 2 The rules of FLS

Flame	Gas	Pump work
Small	Low	Pump off
Normal	Low	Pump off
Large	Low	Pump on
Small	Medium	Pump off
Normal	Medium	Pump on
Large	Medium	Pump on
Small	High	Pump on
Normal	High	Pump on
Large	High	Pump on

The following some rules define the logic behind the operation of the firefighting robot for the fuzzy inference process that is shown implementation in MATLAB in Fig. (4).

1. If gas is “low” and flame is “small” then pump is “pump
2. If gas is “low” and flame is “normal” then pump is “pump
3. If gas is “low” and flame is “large” then pump is “pump on”.
4. If gas is “medium” and flame is “small” then pump is “pump
5. If gas is “medium” and flame is “normal” then pump is “pump on”.
6. If gas is “medium” and flame is “large” then pump is “pump
7. If gas is “high” and flame is “small” then pump is “pump
8. If gas is “high” and flame is “normal” then pump is “pump on.
9. If gas is “high” and flame is “large” then pump is “pump on,

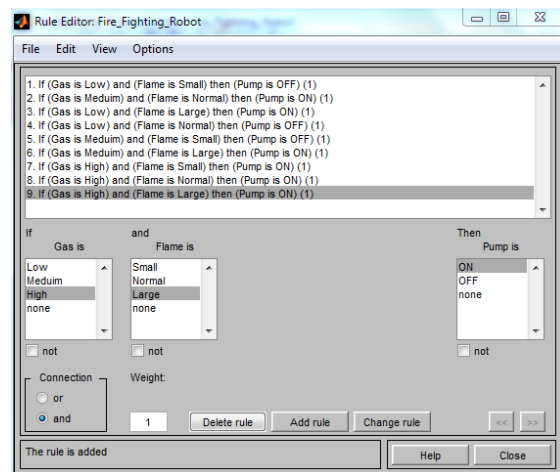

Fig. 4 Rules in MATLAB

The crisp value in defuzzification is just the new fuzzy subset's center of the area under the curve that was obtained during the composition stage. Defuzzification is the process of mapping a fuzzy set—the result of a fuzzy inference engine—to a crisp output that is shown in Fig. (5). As well as the surface view of variables shown in Fig. (6).

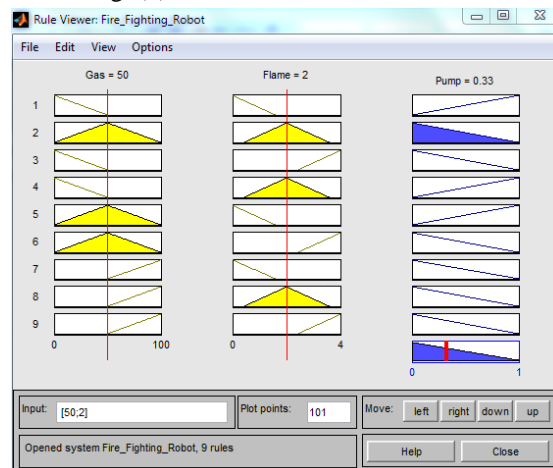

Fig. 5 Output of pump from MATLAB

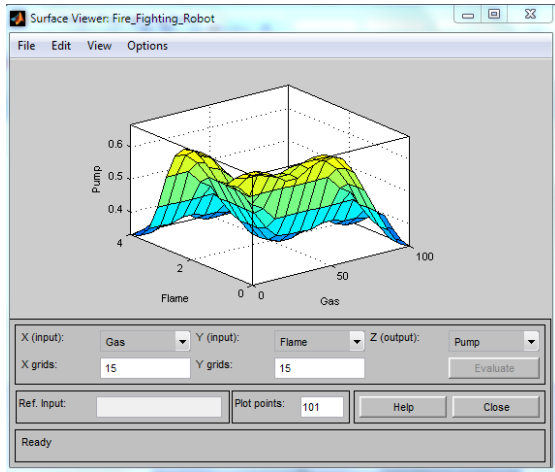

Fig. 6 The surface view of variables.

5 Experimental setup

Aims to develop microcontroller-based fire fighting robot. Monitors the areas where natural calamities and bomb explosion occurs. Sense fire at the site of a disaster by using flame mounted on the robot. If fire is detected with the help of sensors, MCU operates the water pump mechanism depend on power from solar cells. Hardware Description consists of that shown in Fig (7). Flame sensor (specific wavelength range, typically from 760nm to 1100 nm), Arduino, PV Panel, Motor Driver & DC Motor, Servo Motor, Relay, Pump.

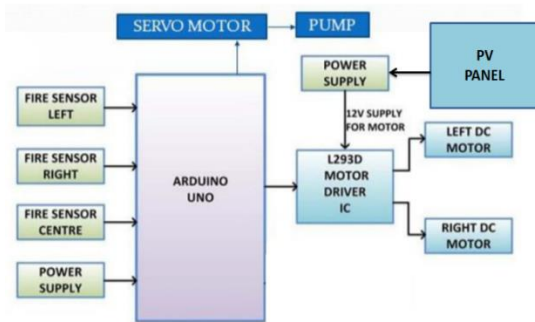

Fig. 7 Block diagram of experimental Setup.

6 Programming

The Arduino software offers core libraries and an integrated development environment (Arduino IDE) for programming. It's simple to write code and upload it to the Arduino Nano for execution using the open-source Arduino IDE using fuzzy logic control in MATLAB that shown in Fig. (8) The hardware configuration is done using the Arduino IDE 1.8.5 version, after which the board and flow chart depicted in Fig. (9) is uploaded. Here, data is gathered from every sensor and entered into an Excel sheet. An additional piece of code is developed in the Arduino IDE to access sensor data in order to facilitate integration between the two programs.



Fig. 8 Arduino IDE program and upload code to Microcontroller.

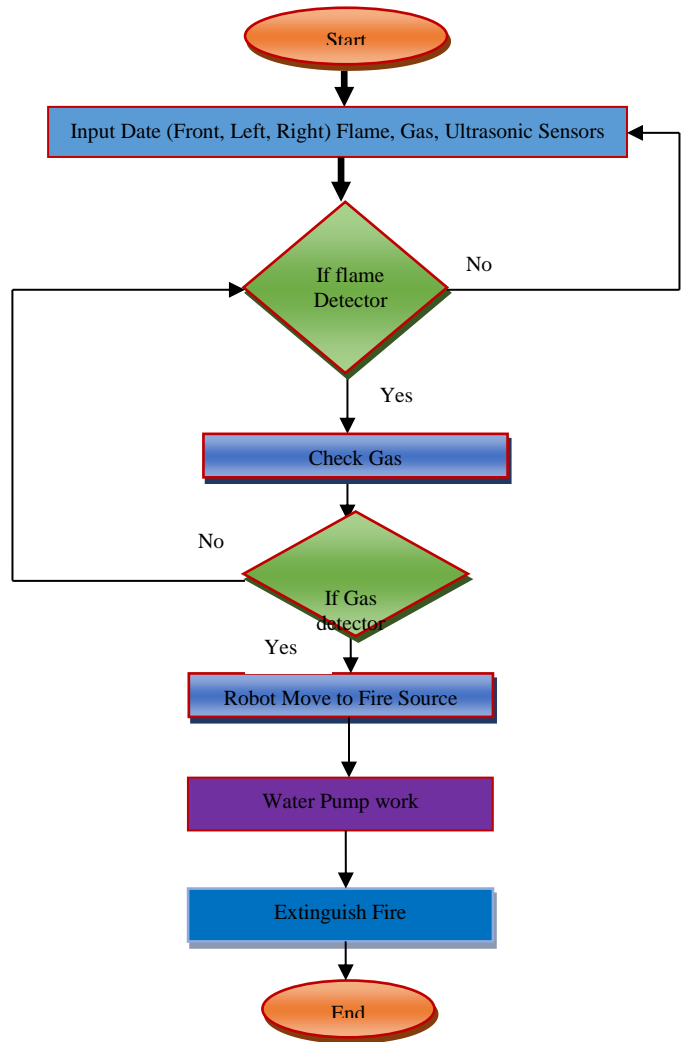

Fig. 9 The flowchart for algorithm implementation.

7 Results and Discussion

Firstly, test the performance of the photovoltaic cell in different climates theoretically and experimentally. The maximum temperature of the sun is measured according to the Standard Test Conditions (STC). The temperature of the PV module also depends on its efficiency. These tests are conducted theoretically using the MATLAB

program using a code in m- File, as shown in Fig. (10), to show I-V, P-V characteristic curve at $T=25^{\circ}\text{C}$ and changing the radiation from 200 to 1000 W/m^2 gradually when it is noted that the amount of solar radiation when there are clouds covering the sky, the result shows. The voltage is very small. When the solar radiation is 1000 W/m^2 , the current increases, and the voltage increases by a very small percentage. Therefore, increasing the amount of solar radiation leads to an increase in the productivity of the panel, and decreasing it leads to a decrease in the productivity of the solar panel.

As well as can be shown in Fig. (11) changing the temperature (25°C , 50°C , 75°C) and solar radiation is 1000 W/m^2 on the I-V, P-V characteristics, the result shows the temperature of the crystalline PV module is generally reduced by 0.3-0.5 percent for each increase in temperature.

The experimentally tests shown in Fig. (12) and Fig. (13) effect the solar radiation decreases to 250 W/m^2 , 500 W/m^2 , 750 W/m^2 and 1000 W/m^2 with changing the temperature (25°C , 50°C , 75°C) on the I-V, P-V characteristics, so it can be seen from the curve that at temperature change when increase caused reduce productivity and reduce performance and efficiency of solar panel. Secondly, show the test performance of the working pump theoretically and experimentally and the firefighting robot shown in Fig. (14), Based on the performance of the sensors (gas, flame) as shown in Fig. (15). To test the proposed system, a different time set is chosen to show flame and gas detection, these practical results are taken from operating the proposed system for several days, monitoring the flame and gas sensors, and then recording the readings. Also, when a fire approaches the system. Finally in Fig. (16) can be seen a firefighting robot implementation.

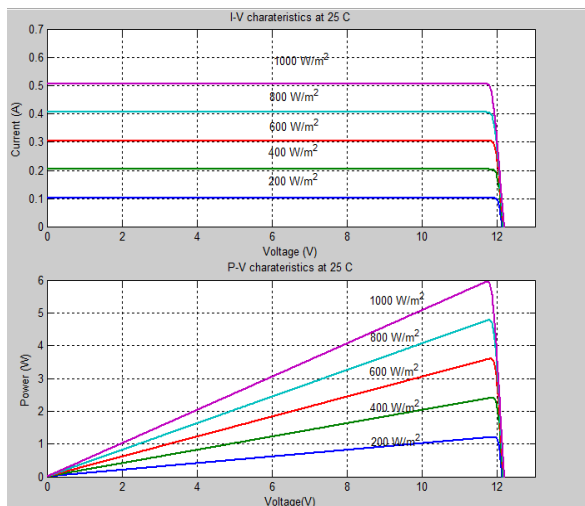

Fig. 10 Power and Current Theoretical at different solar radiation and $T=25^{\circ}\text{C}$.

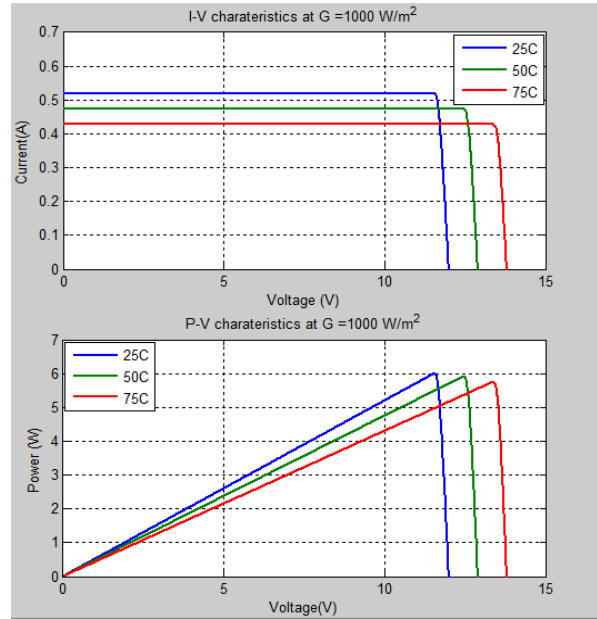

Fig. 11 Power and Current Theoretical at different Temperature and $G=1000\text{ W/m}^2$

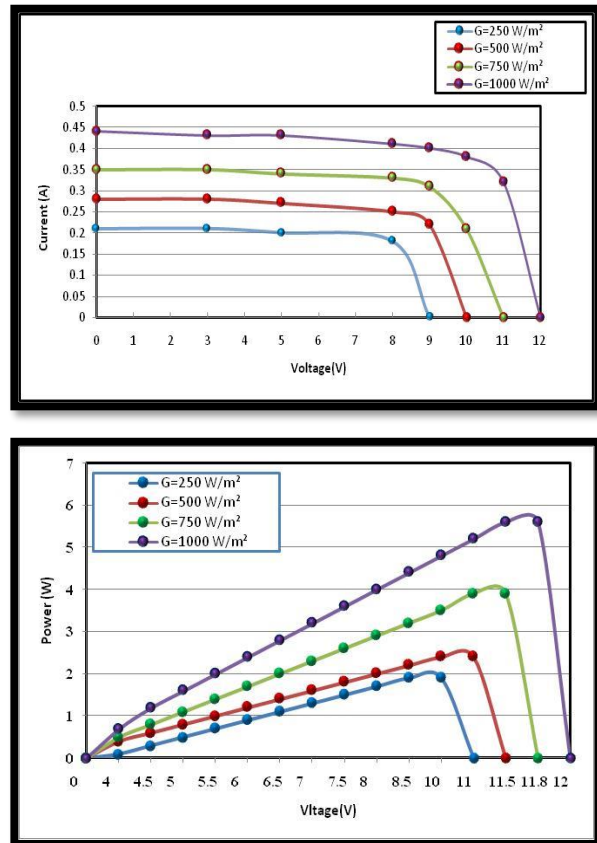

Fig. 12 Power and Current Experimentally at solar radiation different and $T=25^{\circ}\text{C}$.

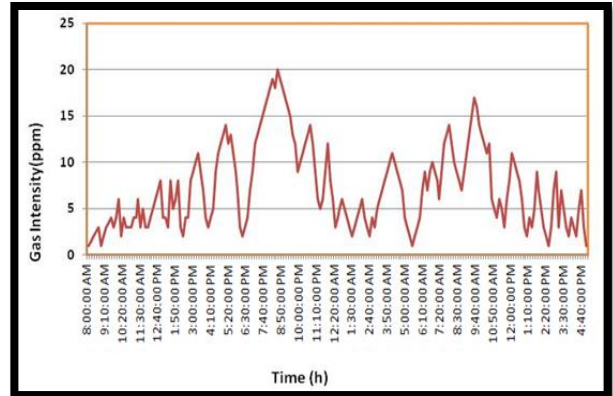
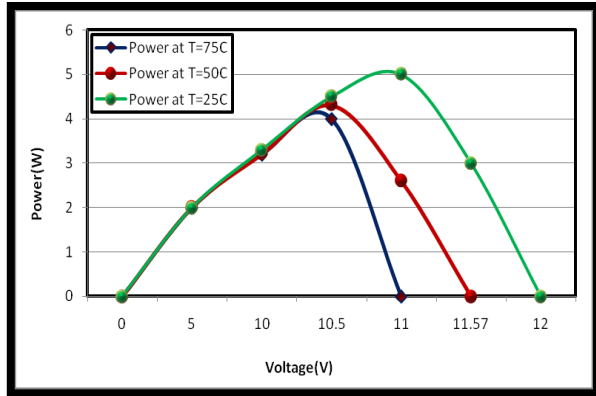

Fig. 15 Performance Flame and gas Sensor.

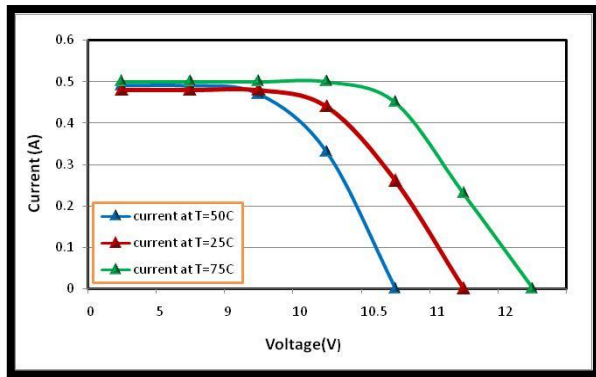

Fig.13 Power and Current Experimentally at different Temperature and $G=1000W/m^2$.

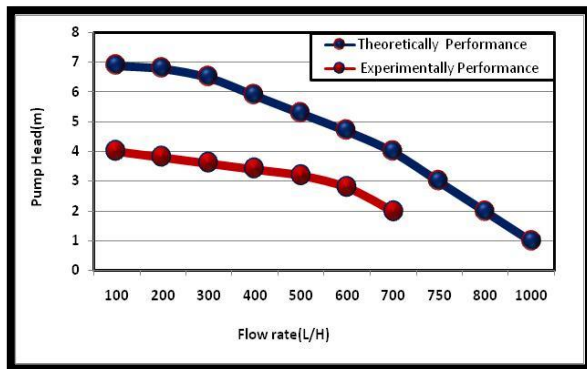

Fig. 14 Theoretically and Experimentally pump performance

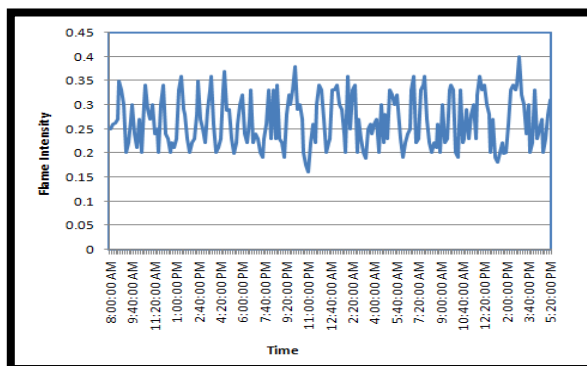



Fig. 16 Fire Fighting robot implementation.

8 Conclusion

This firefighting robot project is to create a system that can recognize and extinguish fires before they spread. Through this paper, can be concluded the benefit of the robot by relying on solar energy to provide energy and ensure its operation at all times. The fire can be extinguished first, and most fires can be extinguished without spreading thanks to the fire extinguishers that can be installed on the robot, relying on a water pumping mechanism through the electrical circuit relay and the pump. Thus, obtaining stable and rapid-fire extinguishing and accurate sensing capability with increased flexibility when applied an artificial intelligence technique known as the fuzzy logic system and give result more effectively, reliably and efficiently, thus avoiding the possibility of falsification. This study applied the basic data of the system in the MATLAB program by introducing flame and gas sensors into the fuzzy logic system and creating a membership function for each input, as well as building rules and obtaining outputs, then linking them to the Arduino microcontroller in the experimental setup, and then monitoring the performance of the gas and flame sensor for several days, as well as recording the readings. The results obtained were 97% accurate to the actual data and this proved the suitability of using this method. This can be contributed to reducing the human effort exerted by firefighters, and it is also reliable, economical and insensitive to weather conditions. This work can be applied in daily life as well as in all industrial applications such as closed parking lots, stores and supermarkets. This robot also fully helps in these natural areas where disasters and bomb explosions have occurred.

References

- [1] A.H. Bagdadee, N. Uddin, Al-Amin, A. Rahaman, Sh. Islam, R. Ahammed, S.M. M.Rahman khan, A Novel Method for Solar Power-Based Fire-Fighting Robot

International Journal of Electrical and Electronics Engineering ISSN: 2348-8379/
<https://doi.org/10.14445/23488379/IJEEE-V11I3P110>
 Original Article Volume 11 Issue 3, 136-147, March 2024 .

- [2] K. Kartik. Prototype Development of Fire Fighting Robot. 10.13140/RG.2.2.36424.1408.,2020.
- [3] M. Victoria, N. Haegel, I. M. Peters, R. Sinton, A.Waldau, C. Cañizo, Ch. Breyer, M. Stocks, A. Blakers, I. Kaizuka, K. Komoto, A. Smets,Solar photovoltaics is ready to power a sustainable future, Joule Volume 5, Issue 2021.
- [4] B.Muhammad ,Sh.Muhammad ,A.Surajo, ,Y. Dele , M.Abdulmuhammad. Robots for Fighting Fires: A Comparative Analysis. 3. 57-61. 10.5281/zenodo.10384140, 2023.
- [5] A. Eswaran, Fellow, A. Vijay, S. Karthick, C. Sheik Mohammed, M. VimalGnanamani College of Technology Solar Powered Automatic Fire Fighting Robot International Journal of Engineering Research & Technology (IJERT) ETEDM - 2018 Conference Proceedings Volume 6, Issue 04 ,2018.
- [6] B. Sarwar, I. Sarwar Bajwa, Sh. Ramzan, B. Ramzan and M. Kausar, Design and Application of Fuzzy Logic Based Fire Monitoring and Warning Systems for Smart Buildings, 9 November 2018.
- [7] J. NavyaSree, N. Ganesh, S. Chandrasekhar, V. Chandrika, P. Sairupa, S. Suma Latha, Fire Fighter Robot Using Renewable Energy ENERGY International Research Journal of Modernization in Engineering Technology and Science (Peer-Reviewed, Open Access, Fully Refereed International Journal) Volume:05/Issue:04/April-2023.
- [8] D. Yogi Goswami ,”Principles of Solar Engineering”. 3rd Edition, CRC Press, February 20, 2015.
- [9] H.Bevrani, A.Ghosh, G.Ledwich,: ‘Renewable energy sources and frequency regulation: survey and new perspectives’, IET Rnew.PowerGener., 2010.
- [10] Compare solar companies, solar panels, and solar prices: SolarReviews (no date). Available at: energyinformative.org/solar-cell-comparisonchart-mono-polycrystalline-thin-film (Accessed: 18 June 2024)
- [11] A. Maksumic, V. Becirovic, S. Hanjalic, H. Samic and S. Maksumic, "Techno-economic analysis of different types of photovoltaic power plants," IEEE. 2018 17th International Symposium INFOTEH-JAHORINA (INFOTEH), East Sarajevo, Bosnia and Herzegovina, 2018, pp. 1-6, doi: 10.1109/INFOTEH.2018.8345517.
- [12] Dunlop, James P" Photovoltaic power systems" , Industries Orland Park, Ill. : American Technical Publishers, Inc.2010
- [13] AbouJieb, E. Hossain "Photovoltaic Systems" Springer ChamNature Switzerland AG 2022eBook ISBN978-3-030-89780-2Published: 07 December 2021 <https://doi.org/10.1007/978-3-030-89780-2>
- [14] Lazaroiu, A.C.; G. Osman, M.; Strejoiu, C.-V.; Lazaroiu, G. A Comprehensive Overview of Photovoltaic Technologies and Their Efficiency for Climate Neutrality. *Sustainability* 2023, 15, 16297.

- [15] R.Jawad, A.Yasser, Ali "Types of cooling technique of PV panel" ,IAP LAMBERT Academic Publishing 2019/7/29
- [16] J. C. Teo, *et al.*, "Impact of Partial Shading on the P-V Characteristics and the Maximum Power of a Photovoltaic String," MDPI Energies, Vol. 11, 2018.
- [17] A. A. Elbaset and, M.S. Hassan, "Design and Power Quality Improvement of Photovoltaic Power System," Springer, International Publishing AG, Switzerland, 2017.
- [18] R. Malik, "Fire Fighting Robot: An Approach", Indian Streams Research Journal Vol.2, Issue.II/March; 12pp.1-4
- [19] K.Kosasih, E. Merry Sartika, M. Jimmy Hasugian, danMuliady, "The Intelligent Fire Fighting Tank Robot", Electrical Engineering Journal Vol. 1, No. 1, October 2010
- [20] H. P. Singh, AkanshuMahajan, N. Sukavanam, VeenaBudhraj, "Control of An Autonomous Industrial Fire Fighting Mobile Robot", DU Journal of Undergraduate Research and Innovation
- [21] H. Xu, H. Chen, C. Cai, X. Guo, J. Fang and Z. Sun, "Design and Implementation of Mobile Robot Remote Fire Alarm System," *2011 International Conference on Intelligence Science and Information Engineering*, Wuhan, China, 2011, pp. 32-36, doi: 10.1109/ISIE.2011.46.
- [22] M. Kanwar and L. Agilandeewari, "IOT Based Fire Fighting Robot," *2018 7th International Conference on Reliability, Infocom Technologies and Optimization (Trends and Future Directions) (ICRITO)*, Noida, India, 2018, pp. 718-723, doi: 10.1109/ICRITO.2018.8748619.
- [23] Yongjun Xu, Xin Liu, et.al, Artificial intelligence: A powerful paradigm for scientific research, The Innovation, Volume 2, Issue 4, 2021, <https://doi.org/10.1016/j.xinn.2021.100179>.
- [24] Eyad I. Abbas Dr. Sundus D. HasanRawaaJawad "PATH FINDING BASED ON ARTIFICIAL INTELLIGENCE TECHNIQUES: A REVIEW "International Journal of Engineering Applied Sciences and Technology (IJEAST), 2020 Vol. 5, Issue 4, ISSN No. 2455-2143, Pages 91-100 August 2020.
- [25] N. Kumar, M. Takács, and Z. Vámosy, " Robot navigation in unknown environment using fuzzy logic " IEEE 15th International Symposium on Applied Machine Intelligence and Informatics (SAMI), 2017.
- [26] Wang Y, Yu C, Tu R, Zhang Y. Fire detection model in Tibet based on grey-fuzzy neural network algorithm. *Expert Systems with Applications*. 2011; 38(8):9580-6.
- [27] Přibyl P, Přibyl O. Calibration of a fuzzy model estimating fire response time in a tunnel. *Tunnelling and Underground Space Technology*. 2017; 69:28-36.
- [28] Kumar K, Sen N, Azid S, Mehta U. A fuzzy decision in smart fire and home security system. *Procedia Computer Science*. 2017; 105:93-8.
- [29] Ross TJ. *Fuzzy logic with engineering applications*. New York: Wiley; 2004.



Rawaa Jawad received her B.Sc. in Electrical Engineering from University of Technology, Baghdad, Iraq in 2010. In 2020 she has a master degree in Electronic and Communication Engineering from University of Technology, Baghdad, Iraq. She interested in Power Engineer, Image processing, Robotics, signal processing, Control System Artificial Intelligent, Optimization algorithms. She is currently an academic staff at the department of mechanical engineering, University of Technology ,Baghdad, Iraq.



Raheel Jawad received her B.Sc. in Electro Mechanical Engineering from University of Technology, Baghdad, Iraq in 2011. In 2018 she has a master degree in Electro Mechanical Engineering (energy department) from University of Technology, Baghdad, Iraq. She interested in Power Engineering, Energy and Renewable energy, Control System Artificial Intelligent and Optimization algorithms.