

Effects of Geosynthetic Reinforcement on the Propagation of Reflection Cracking in Asphalt Overlays

A. Khodaii^{1,*}, Sh. Fallah²

Received: May 2008, Accepted: March 2009

Abstract: An experimental program was conducted to determine the effects of geosynthetic reinforcement on mitigating reflection cracking in asphalt overlays. The objectives of this study were to assess the effects of geosynthetics inclusion and its placement location on the accumulation of permanent deformation. To simulate an asphalt pavement overlaid on top of a crack in a concrete or asphalt pavement, an asphalt mixture specimen was placed on top of two discontinuous concrete or asphalt concrete blocks with 100 mm height. Four types of specimens were prepared with respect to the location of geogrid: (I) Unreinforced samples, which served as control specimen, (II) Samples with geogrid embedded on the concrete or asphalt concrete block, (III) Samples with geogrid embedded one-third depth of asphalt concrete from bottom, (IV) Samples with geogrid embedded in the middle of the asphalt beam. Each specimen was then placed on the rubber foundation in order to be tested. Simulated- repeated loading was applied to the asphalt mixture specimens using a hydraulic dynamic loading frame. Each experiment was recorded in its entirety by a video camera to allow the physical observation of reflection crack formation and propagation. This study revealed that geosynthetic reinforced specimens exhibited resistance to reflection cracking. Placing the geogrid at the one-third depth of overlay thickness had the maximum predicted service life. Results indicate a significant reduction in the rate of crack propagation and rutting in reinforced samples compared to unreinforced samples.

Keywords: Reflection cracking, asphalt, overlays, deformation, geosynthetics

1. Introduction

1.1. Overview

One of the more serious problems associated with the use of thin overlays is reflective cracking. This phenomenon is commonly defined as the propagation of cracks from the movement of the underlying pavement or base course into and through the new overlay as a result of load-induced and/or temperature-induced stresses [1].

The reflection crack has two major driving forces:

1- The external wheel load; this contributes to high stress and strain levels in the overlay above the existing crack. The discontinuity in the existing pavement reduces the bending stiffness of the rehabilitated pavement section and creates a stress concentration. When conditions are such that the stress state exceeds the fracture resistance of the overlay, a reflective crack can be initiated

and / or propagated. A combination of mode I (opening) and mode II (shearing) stress leads to crack propagation through the overlay [2].

2- Daily temperature variations; the contraction of the discontinuous underlying pavement leads to additional concentrated tensile stresses in the overlay above the existing crack or joint. This phenomenon is almost exclusively linked to the pure mode I crack opening mechanism [3].

Because of a number of variables involved in the nature of reflection cracking no solution for completely preventing of these cracks propagation has been suggested yet. Only retardation of crack progress is the best solution strategy adopted so far. Inclusion of geosynthetic interlayer may enhance the resistance to reflection cracking either by a stress-relief or a reinforcement mechanism, or by a combination of both.

1.2. Literature Review

During the past decade or so, various researchers have proposed solution to retard reflection cracking based on field, laboratory and numerical investigation [4]. The field

* Corresponding Author: khodaii@aut.ac.ir

1 Assistant Professor, Department of Civil Engineering, Amirkabir University of Technology, Tehran, Iran

2 M. Sc Student in Highway Division, Department of Civil Engineering, Amirkabir University of Technology, Tehran, Iran

performance of geogrid- reinforced overlay was varied because it depends on construction procedures, position of geogrid, interfacial treatment between layers, and weather conditions [5].

Guo et al. [6] studied geogrid- reinforced asphalt overlay in the field in 1993 and found that the glass fiber grid placed at the bottom of overlay was effective in limiting cracks near the interface and increasing of bending strength by 42% and of fatigue life by 80%. Fujio Yuge et al. [7] conducted field test and their study showed that thick asphalt overlay reinforced with geogrid did decrease surface deflection and two layers of geogrid are even more effective than single layer.

In 1999, Kim et al. [8] conducted lab test to study mode I reflection cracking in asphalt overlay with polymer- modified asphalt mixture and glass grid or polypropylene film. To simulate an asphalt pavement overlaid on top of a crack in concrete pavement, an asphalt mixture specimen was placed on top of two discontinuous concrete blocks. Their result showed that when modified asphalt mixture was reinforced with the glass grid at the bottom of the asphalt layer, its fatigue life increased by a factor of 16.7. Brown et al. [9], Chang et al. [10] and Sobhan et al. [11] placed asphalt beam specimens on two pieces of plywood that had a 10 mm gap at center to simulate an existing joint or crack underneath the overlay, with the whole system placed on a rubber base representing the soil foundation. Reddy et al. [12] studied the propagation of reflection cracks by placing asphalt beam specimens on small concrete blocks (at different gap intervals) simulating the broken PCC resting on an elastic foundation prepared with compression springs. Goulias and Ishai [13] used a wheel-tracking device to test an overlay with a pre-sawn crack or notch underneath the specimens.

The studies described below were based on finite element analyses to simulate crack propagation in asphalt overlay. The cracking mechanism and growth inspired plenty of studies in order to remedy the problem. Castell et al. [14] predicted crack growth rate with maximum strains and found bottom-up cracking is more likely to be found than top-down cracking. Thick

overlay was once considered to prevent bottom-up reflective cracks. Yet, Uhlmeier et al. [15] investigated thick overlay and found cracks starting at surface and propagate down ward. Sha [16] also noticed top-down reflection cracking happened for thick overlay according to field observation in China. Kuo and Hsu [5] used the ABAQUS finite element program to model geogrid- reinforced asphalt overlay on the old PCC pavement with joint/crack. Old pavement support was modeled with continuous springs as Winkler foundation. They concluded that placing the geogrid at one third depth of asphalt overlay thickness from bottom had the minimum tensile strain. After this position, placing the geogrid in the middle of asphalt overlay was the best placement for reducing tensile stress above geogrid compared with the specimens with geogrid placed at the bottom of overlay.

In present study, a laboratory experiment program and detailed analysis were employed. The primary objectives of the experimental phase were as follows: (I) to study the effects of placement of geosynthetic in overlay under the condition of mode I (bending) on the growth and propagation of reflection crack over different existing pavement (asphalt or concrete), (II) to quantify the effectiveness of geosynthetics in retarding reflection cracking in asphalt overlay with different gap opening in old pavement, (III) to study the effect of geosynthetic position and type of old pavement on direction of crack propagation (bottom-up or top-down cracking) in asphalt overlay. In the course of study, an experimental technique was developed for mode I fracture testing using a servo hydraulic dynamic testing machine. This paper presents the methodology and some of significant result obtained from the work.

2. Experimental program

2.1. Test set up

The current study evaluated different test configurations based on Kim et al. [8], Brown et al. [9], Chang et al. [10] and Sobhan et al. [11] researches and developed a set up shown schematically in Fig. 1. Also ratios of loading plate dimensions and pressure on top of the

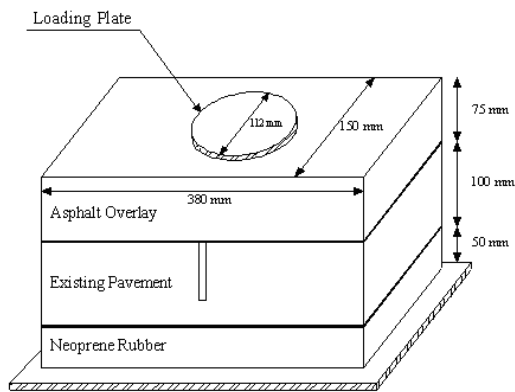

Fig. 1 Schematic of test set up

Table 1. Scope of experimental variable

Existing pavement	Geogrid position*	Width of crack/joint (mm)
Concrete	Non	10-15-20
	One- third	
	Middle Bottom	10
Asphalt concrete	Non	10-15-20
	One- third	
	Middle Bottom	10

* Distance from bottom of overlay

specimen to that of the specimen were similar to Kim et al. [8], Youngqi Li et al. [17] and Sobhan et al. [11]. Before choosing these dimensions for the samples, numerical study with ANSYS.10 was also performed and the results showed the size effects are in-significant and negligible for these dimensions of the samples. This study consists of the following major components representing a layered pavement structure: (a) an asphalt overlay $380\text{mm}^L \times 150\text{mm}^W \times 75\text{mm}^H$, which may be unreinforced or reinforced in any depth, (b) a block of asphalt or concrete, simulating discontinuous existing pavement (depth 100 mm) and (c) a resilient subgrade modeled with neoprene rubber with elastic modulus of 11MPa.

Simulated-repeated loading was applied to the specimens using a hydraulic dynamic loading frame. Cyclic square loads were applied to the top center of the beam through a circular loading plate (112 mm diameter) with frequency of 10 Hz simulating high speed traffic. A maximum load of 6.79 kN was applied to the specimen to create

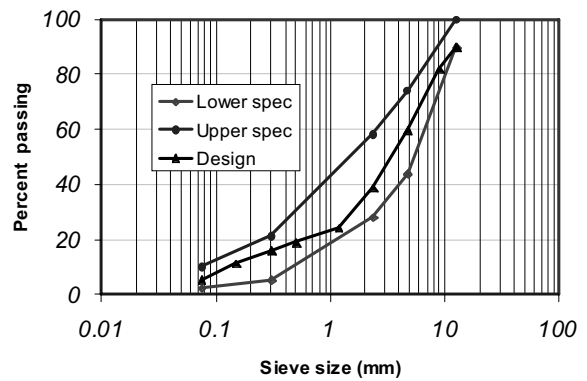

Fig. 2 Aggregate gradation used in asphalt concrete

690 kN/m² or 100 psi pressure on top of the specimen to model a truck wheel load. A 196 N minimum load was used to keep the loading plate in place during dynamic loading. UTM servo-hydraulic machine with computerized test control and data acquisition system was used for conducting the experimental program. The specimens were tested at 20 °C . Before the specimens were tested, they were kept in a temperature chamber at the desired temperature for 2 hours. Table 1 shows the independent variables and their values used in the study.

2.2. Materials Used

The AC used in this study to represent the overlay and old pavement is made of coarse aggregate, and asphalt binder. The grading of mix aggregate with the specification limits given by Iran Highway Asphalt Paving Code [18] is plotted in Fig. 2, with the specification requirements. Bitumen, AC 60-70 (penetration grade of 60-70), the most widely used in Iran, was used as binder for mixture preparation. The optimum asphalt binder content was 5.2% by weight of hot mix asphalt for each specimen.

The coarse aggregate used in the existing concrete pavement had a maximum size of 19 mm. The fine aggregate constituent was natural sand with a specific gravity of 2.54. The coarse and fine aggregate gradations met the BS 882 [19]. Water to cement ratio was 0.52. The elastic modulus and compressive strengths for concrete specimens were 2.85×10^7 kN/m² and 343×10^2 kN/m² respectively.

2.3. Material and property of grid

The geogrid used was one of the most frequently available and deployed in the country that was 100% polyester with tensile strength of 50 kN/m and 12% strain in machine direction and 14% strain in cross machine direction and its mass per unit area was 240 g/m². Grid size was 40 mm × 40 mm.

2.4. Specimen Preparation and Placement Configuration

To simulate an asphalt overlay on top of a crack in concrete pavement, an asphalt mixture was designed using Marshall procedure and placed on top of two discontinuous concrete blocks with 100 mm height. The asphalt mixture specimen was bonded using a tack coat on top of the concrete block that had a 10 mm, 15 mm or 20 mm gap cut 2/3 the depth from the top. The crack or joint was made at the centerline of the old block using a water cooled circular saw with a diamond blade. For each asphalt overlay, aggregate and binder were heated and mixed at a temperature of 150 °C. The amount of tack coat used between asphalt layer and concrete block was equal to 4.9×10^{-3} kN/m² and was AC 85-100 penetration grade. The concrete block was placed in a steel mold with dimensions of 380mm^L × 150mm^W × 200mm^H. A known weight of the

hot mixture was poured on concrete block in the steel mold in four layers. The hot mixture was compacted to desired height using hydraulic jack fitted with a flat steel plate 20 mm in thickness.

Table 2 shows the height and weight for each layer of overlay. Since the location of geogrid for each type of specimen was different, these thicknesses were selected for all of the specimens in order to reach the same specific density.

The hot mixture was compacted to desired height using hydraulic jack fitted with a flat steel plate 20 mm in thickness. This procedure produced consistent specimens with the desired dimension and density. Specimens were prepared in four lifts at a target void content of 8.5% and weight of 2.123 kN/m³. Although the density of the compacted HMA specimen is slightly lower than the typical density used in the field, this density level was selected because it could be consistently achieved with the available hydraulic press in the laboratory. The following four types of specimens were prepared: (I) unreinforced specimens, which served as control specimens, (II) specimens with geogrid placed on the concrete block, (III) specimens with geogrid embedded in one third depth of asphalt concrete from bottom. This was achieved by placing the geogrid on top of compacted first layer prior to pouring and compacting the loose mix of the next three layer, (IV) specimens with geogrid embedded in the middle of the asphalt overlay, produced by placing the geogrid on top of compacted second layer prior to pouring and compacting the loose mix of the next two layer. In two previous specimen preparations (III and IV), reinforcement was sandwiched within the overlay.

The old asphalt concrete block was made from compacting of mixture in four layers in the steel



Fig. 3. Test specimen under load

Table 2. Height and weight for each layer of asphalt overlay

Layer number	Layer Thickness (mm)	Weight (kg)
Layer 1	25.00	2.85
Layer 2	12.50	1.43
Layer3	18.75	2.14
Layer4	18.75	2.14

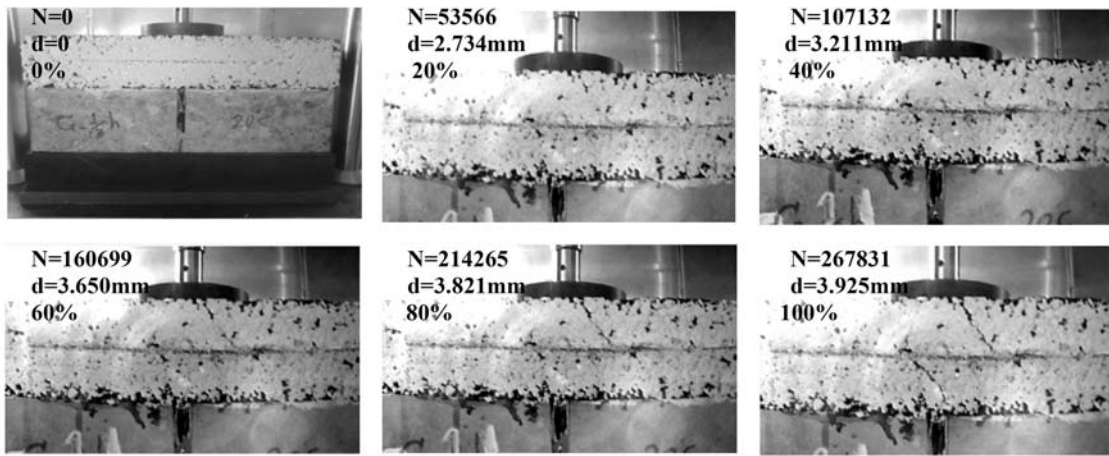

(a). Reinforced overlay with existing concrete block (10 mm crack/joint)

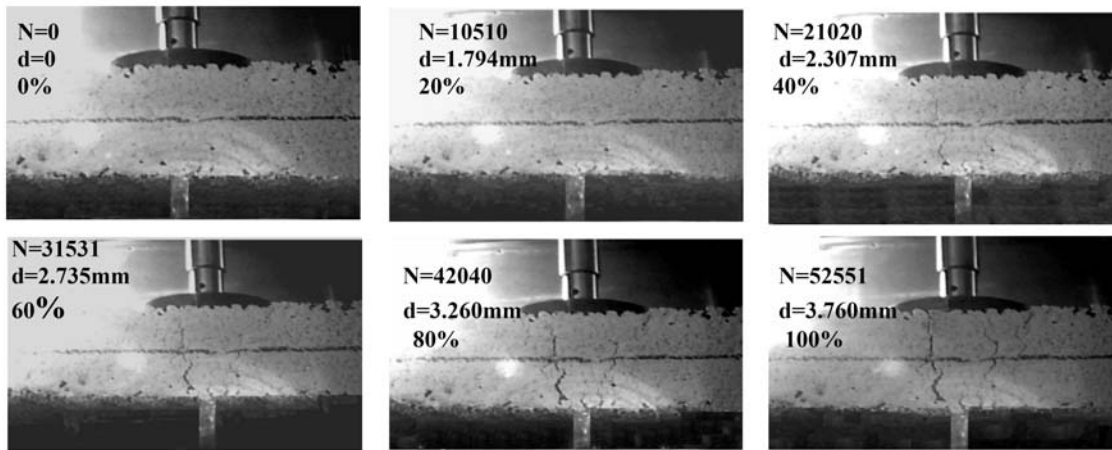

Fig. 4 Progression of reflection cracks at 20 °C for (a) geogrid reinforced (embedded at one-third) overlay and (b) unreinforced overlay.

Note: N= the number of cycle and d= deflection at this cycle and 0%, 20%, 40%, 60%, 80%, 100% corresponds the fatigue life percents.

mold (25 mm thickness for each layer). The characteristics of cracked asphalt were similar to asphalt overlay. To simulate an asphalt overlay on top of the existing asphalt pavement with crack, the preparation was the same as the asphalt overlay preparation on the concrete block with joint/ crack. Each specimen was then placed on the rubber foundation for testing with a hardness of Shore A=60 and Elastic Modulus of 11 MPa as shown in Fig. 3.

Two replicate specimens were fabricate and tested for each factor combination. A total of 32 specimens were tested.

Each experiment was recorded in its entirety by a video camera to allow the physical observation of reflection crack formation and propagation. Vertical crack growth was

monitored from one side which was painted white with a water-based paint. The test was conducted until the vertical crack length reached the full specimen overlay depth (75mm).

3. Result and analysis

Fig. 4 shows typical failed, one-third embedded geosynthetic reinforced AC with concrete block base that had a 10 mm crack/joint and unreinforced sample with asphalt block base that had a 10 mm crack at different stages of failure. Also vertical deformation was measured using the built in actuator of UTM servo-hydraulic machine.

Dynamic stability, DS, was measured from the permanent deformation curves as described in

Table 3. Mode I reflection crack propagation test results

Existing pavement	Width of joint/crack (mm)	Geogrid position	Fatigue life (cycles)	Vertical displacement (mm)	Vertical DS (cycles/mm)	
Concrete	10	Non	31551	2.796	28873	
	10	Bottom	64311	3.492	38597	
	10	One-third	254653	3.811	169926	
	10	Middle	216732	4.144	93180	
	15	Non	27831	3.028	22122	
	15	One-third	193911	3.914	113265	
	20	Non	19311	3.882	10706	
	20	One-third	168782	3.911	146475	
	Asphalt concrete	10	Non	52551	3.761	21325
		10	Bottom	153211	5.443	48557
10		One-third	354942	5.201	293773	
10		Middle	267302	6.020	198377	
15		Non	39567	5.286	10653	
15		One-third	231540	6.691	67603	
20		Non	20031	6.239	5232	
20		One-third	127810	8.449	23453	

Fig. 5. This value presents how many loading cycles were required for the specimen to deform 1 mm vertically. The values in Table 3 are an average of the two specimens.

3.1. Effects of type of underlying pavement on the optimum location of geosynthetic

3.1.1. Effect of old Concrete pavement

The crack propagations for specimens over existing concrete pavement were different depending on placement position of geogrid in overlay. In the case of geogrid embedded at the bottom of overlay, cracks occurred just over the joint. Then cracks developed under the loading continued to penetrate the entire layer and reached top of overlay. But in the case of geogrid embedded in middle or one-third depth, top down cracking pattern was identified. Immediately under the loading plate, cracks developed from bottom of lower layer of AC overlay. Then the cracking energy was trapped by geogrid. Finally, the upper layer of AC overlay started to crack from top and propagated towards geogrid. This phenomenon was similar to what reported by Kuo and Hsu [5]. Placing geogrid at one-third or middle of overlay thickness divides the overlay into lower layer and upper layer. This design is advantageous with lower layer serving as leveling layer that ensure good seating and bonding of geogrid. According to Jayawickrama et al. [4], Kuo and Hsu [5] and Brown et al. [9],

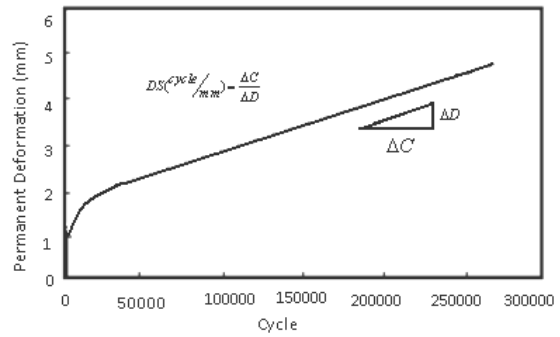

Fig. 5 Description of dynamic stability

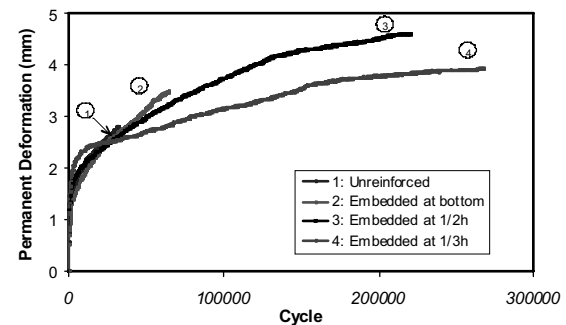

Fig. 6 Permanent deformation over fatigue life for overlays with concrete block base and 10 mm gap at 20 °C

when geosynthetic was placed inside asphalt overlay, different stress distribution above and below geosynthetic was produced. So the neutral axis was changed by changing of geosynthetic placement in asphalt overlay.

Fig. 6 shows permanent deformation vs. load cycle for geogrid reinforced and control samples without geogrid with 10 mm gap in concrete block. In general, fast vertical deformation occurs initially and then the slope of curves stabilizes. This is due to consolidation of mixtures at the initial stage of load application. It is observed that samples with reinforcement embedded in one-third depth lasted longer than those embedded at the bottom. Fatigue life of reinforced overlay with geogrid placed at one-third depth was 8.1, 3.9 and 1.2 times greater than unreinforced sample, sample with geogrid embedded at bottom and sample with geogrid embedded at middle of overlay respectively. Also Kuo and Hsu [5] (Numerical studies) showed that placing the geogrid at one third depth of asphalt overlay thickness from bottom with old concrete pavement had the minimum tensile strain above

geogrid and therefore had a maximum fatigue life compared with the specimens with geogrid placed at the bottom or in the middle of asphalt overlay. After this position, placing the geogrid in the middle of asphalt overlay was the best placement for retarding the reflection cracking compared with the specimens with geogrid placed at the bottom of overlay. They also noted that placing geogrid inside asphalt overlay, distributes energy into two sub-layers.

It was observed that permanent deformation of unreinforced sample before terminal cracking (at 31551 cycles) was 1.1 times greater than specimen with geogrid embedded at one-third depth at the same cycles.

Dynamic stability (DS) of the unreinforced specimen was 28873 cycles/mm and that of sample with geogrid embedded in one-third depth was 169926. This means that to create 1 mm of deflection, approximately 17×10^4 cycles of loading with 690 kN/m^2 (100 psi) pressure is required in specimen with geogrid embedded in one-third depth. This number is approximately 5.9 times greater than that of the unreinforced specimen.

3.1.2. Effects of old asphalt concrete pavement

Crack propagation procedures for all of specimens with crack in old asphalt block base were the same. Cracks occurred first between geogrid and overlay AC. Then cracks developed from bottom of overlay and propagated to the surface. Yet, unreinforced specimen had wider cracks than reinforced specimens. As shown in Fig. 7, the best location of geogrid for reflection crack was found to be one-third depth from bottom of overlay that had a fatigue life 6.7 times greater than unreinforced specimen. Sobhan et al. [11] studies showed that if the geosynthetic is embedded at middle of overlay it will provide a fatigue life greater than embedded in bottom. It should be noted that they did not make a reinforced specimen in one-third depth from bottom.

Samples with geogrid embedded at middle or one-third sustained more than 1.4 times the deformation of unreinforced specimens. However they withstood over 5.8 times the

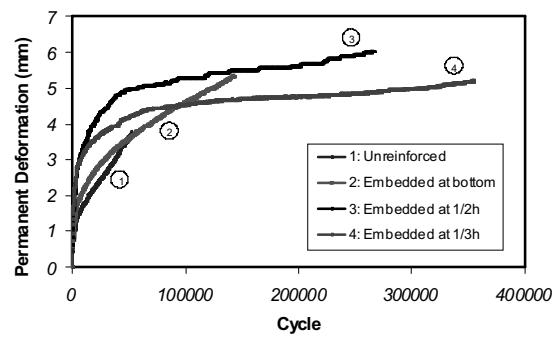

Fig. 7 Permanent deformation over fatigue life for overlays with asphalt block base and 10 mm gap at 20 °C

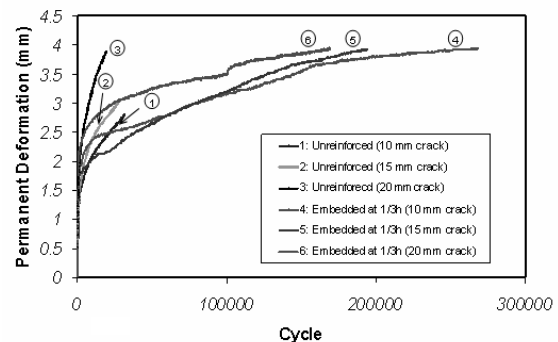

Fig. 8 Permanent deformation for unreinforced and reinforced overlays in one-third depth with concrete block base at 20 °C

number of cycles before terminal cracking.

Vertical crack growths for these specimens were slower than the samples with concrete blocks. But in these samples crack width especially on the crack tip were bigger than specimens with concrete blocks. It is observed that samples with reinforcement embedded in middle and one-third depth of overlay lasted longer than when embedded at bottom while accumulating less permanent deformation.

3.2. The effect of width of joint/crack in old pavement in geogrid application

Because the best location for geosynthetic in overlay with old asphalt or concrete block that had 10 mm gap interval was one-third depth from bottom of overlay, the other reinforced samples with reinforcement in one-third depth with different gap interval were made to compare with unreinforced samples with different gaps in block. Three crack/joint widths were selected, 10 mm to simulate cracks developed in asphalt

pavement and 15 or 20 mm to simulate a joint opening in an existing concrete pavement to be overlaid by asphaltic mixes.

As shown in Fig. 8 and Table 3, reinforced overlay on concrete block with 20 mm gap interval had 66% of fatigue life of reinforced overlay on PCC with 10 mm joint/crack. However, specimen with geogrid embedded in one-third depth of overlay over a concrete block with 20 mm joint had service life 8.7 times and approximately same permanent deformation before terminal cracking of that of unreinforced specimen with 20 mm gap. Also Samples over an asphalt block base with 15-20 mm gap had a greater crack growth rate and deformation in fatigue life and lower service life and dynamic stability when compared with those placed over a 10 mm gap asphalt block base (Fig. 9).

The results in general indicate that the effect of reinforcing geogrid in overlay with increasing joint/ crack in existing pavement was almost constant.

Service life for all various conditions is shown in Fig. 10. From this figure, the most and least effective geogrid position in asphalt overlay in relation to resistance to reflection cracking can be easily distinguished.

4. Conclusion

Data collected from these experiments verifies that geogrid inclusion in asphalt sample lead to significant increase in overlay performance. Specimen with embedded geogrid outperformed non-reinforced samples both in terms of resistance to cracking as well as rutting. Although placing geogrid at one-third depth forces the contractors to pour the overlay in two separate layers and hence encounter some extra cost, this position is most effective in retarding reflection cracking. This phenomenon is independent of type of old pavement. This design is advantageous with lower layer serving as leveling layer that ensure good seating and bonding of geosynthetic.

The effect of geogrid for overlay reinforcing with increasing crack/joint from 10 to 20 mm in existing pavement was not decreased. According

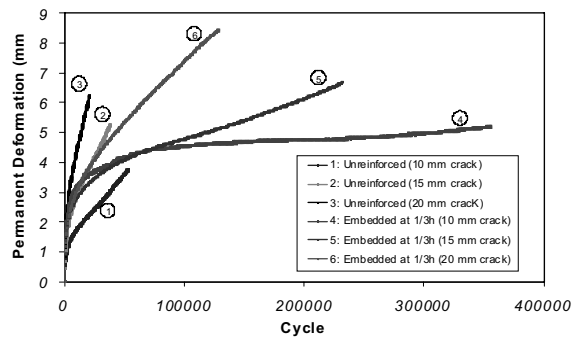

Fig. 9 Permanent deformation for unreinforced and reinforced overlays in one-third depth with asphalt block base at 20 °C

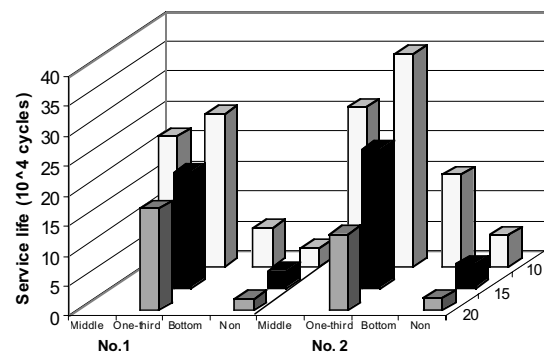

Fig.10 Comparison of service life for various conditions Note: No.1 and No. 2 represents overlay with old concrete block and asphalt concrete block respectively, 10, 15 and 20 corresponds to the width of crack in old block in mm.

to result section, top down cracking pattern in overlay is depending on:

1. Geogrid position in asphalt overlay
2. Relative stiffness of overlay to old pavement.

Future test should focus on thermal cracking tests on reinforced specimens with different geogrid position in overlay to study the effect of subsequent shrinkage and expansion of old concrete pavement in bottom of overlay for optimizing the placement of geosynthetic in overlay.

Acknowledgment

Gratefully acknowledge the financial support from Road Maintenance and Transportation Organization of Iran.

References

- [1] Cleveland, G.S, Button, J.W, Lytton, R.L.: 2002, Geosynthetics in Flexible and Rigid Pavement Overlay Systems to Reduce Reflection Cracking, Report No.FHWA/TX 02/1777,Texas Department of Transportation Research and Technology Implementation Office. pp.1-297.
- [2] De Bondt, A.H.: 1998, Anti-reflective cracking design of (reinforced) asphalt overlays, PhD Thesis, Dept. of Civil Engineering, Delft Univ. of Technology, Delft, The Netherlands.
- [3] Kim, J. and Buttlar, W.G.: 2002, Analysis of reflective crack control system involving reinforcing grid over based-isolating interlayer mixture', Journal of Transportation Engineering, Vol.128, No.4, July/August, pp. 375-384.
- [4] Jayawickrama, P.W. and Lytton, R.L.: 1987, Methodology for Predicting Asphalt Concrete Overlay Life Against Reflective Cracking, Proceedings, 6th International Conference on the Structural Design of Asphalt Pavements, Vol. 1.
- [5] Kuo, Ch.M, Hso, T.R.: 2003, Traffic Induced Reflective Cracking on Pavements with Geogrid Reinforced Asphalt Concrete Overlay, 82th Annual TRB Meeting, pp.1-23.
- [6] Guo, Z, and Zhang, Q.: 1993, Prevention of Cracking Progress of Asphalt Overlayer with Glass Fabric', Reflective Cracking in Pavements: State of the Art and Design Recommendations: Proceedings of the Second International RILEM Conference, Liege, Belgium, 10-12. , pp. 398-405
- [7] Fujio Yuge, Masahiko Ishitani, Atsushi Kasahara, and Hiroshi Kubo.: 1993, Prevention of Reflection Cracking in Asphalt Overlay on Concrete Pavement with Glass Grids ,Proceedings, Paving in Cold Area Workshop, Vol 5.
- [8] Kim, K.W., Doh, Y.S. and Lim, S.: 1999, Mode I Reflection Cracking Resistance of Strengthened Asphalt Concrete, Journal of Construction and Building MATERIALS , 13. pp. 243-251.
- [9] Brown, S.F, Brunton, J.M, and Armitage, R.J.: 1989, Grid Reinforced Overlays, Reflective Cracking in Pavements: Assessment and Control, Proceedings of the RILEM Conference, Liege, Belgium, March 8-10, pp. 63-70.
- [10] Chang, D.T.-T, Lai, R -Q, Chang, J.-Y, and Wang, Y.-H.: 1998, Effects of Geogrid in Enhancing the Resistance of Asphalt Concrete to Reflection Cracks, ASTM STP 1348, American Society for Testing and Materials, pp. 39-51.
- [11] Sobhan, K., Genduso, M, and Tandon, V.: 2005, Effects of Geosynthetic Reinforcement on the Propagation of Reflection Cracking and Accumulation of Permanent Deformation in Asphalt Overlays, Third LACCET International Latin American and Caribbean Conference for Engineering and Technology (LACCET 2005) Advances in Engineering and Technology :A Global Perspective. 8-10 June 2005 Cartagena, Columbia, pp, 1-9.
- [12] Reddy, S,K, Reddy, R,K. and Pandey, B,B.: 1999, Cracking in Bituminous Layers Placed Over Cracked Pavements, Presented at the 78th Annual Meeting of the Transportation Research Board, January, Washington, D.C.
- [13] Goulias, D.G, and Ishai, I.: 1999, Experimental System for Simulating Crack Propagation in Asphalt Pavements and Effectiveness of Geosynthetics in Crack Retardation, Journal of Testing and Evaluation, ASTM, Vol. 27, No. 2, pp. 106-113.
- [14] Castell, M.A, Ingraffea, A.R, and Irwin, L.H.: 2000, Fatigue Crack Growth in Pavements, Journal of Transportation

Engineering, ASCE, Vol.126, No.4, pp.283-290.

[15] Uhlmeyer, J.S, Pierce, L.M, Willoughby, K. and Mahoney, J.P.: 2000, Top-Down Cracking in Washington State Asphalt Concrete Wearing Courses, presented in 79th Annual Meeting of Transportation Research Board, Washington D.C.pp.110-116.

[16] Sha, Qing-Lin.: 1993, Two kinds of Mechanism of Reflective Cracking, Reflective Cracking in Pavements: State of the Art and Design Recommendations: Proceedings of the Second International RILEM Conference, Liege,

Belgium.pp.441-448.

[17] Yongqi Li, P.E., and Metcalf, J.B.: 2002, Crack initiation model from asphalt slab tests, Journal of Materials in Civil Engineering, Vol 14, No. 4, August 1, 2002, pp.303-310.

[18] Iran Highway Asphalt Paving Code: 2003, Ministry of Road and Transportation Research and Education Center, Iran, No. 234.

[19] British Standards Institution, BS 882: Part 2: 1973, Coarse and fine aggregates from natural sources. London, BSI.